

Topographic Wiring of the Eye to the Brain

Dr. Greg Lemke, Salk Institute

KITP, March 5, 2003

Colleagues

Arthur Brown

Ashish Vaidya

Paul Yates

Tom Jessell

Patrick Burrola

Sam Pfaff

Dan Ortuño

Dennis O'Leary

Darcie Baynes

Todd Garvey

Michaël Reber

Joe Hash

Stefano Bertuzzi

Robert Hindges

Stina Mui

Jin Woo Kim

Topographic Wiring of the Eye to the Brain

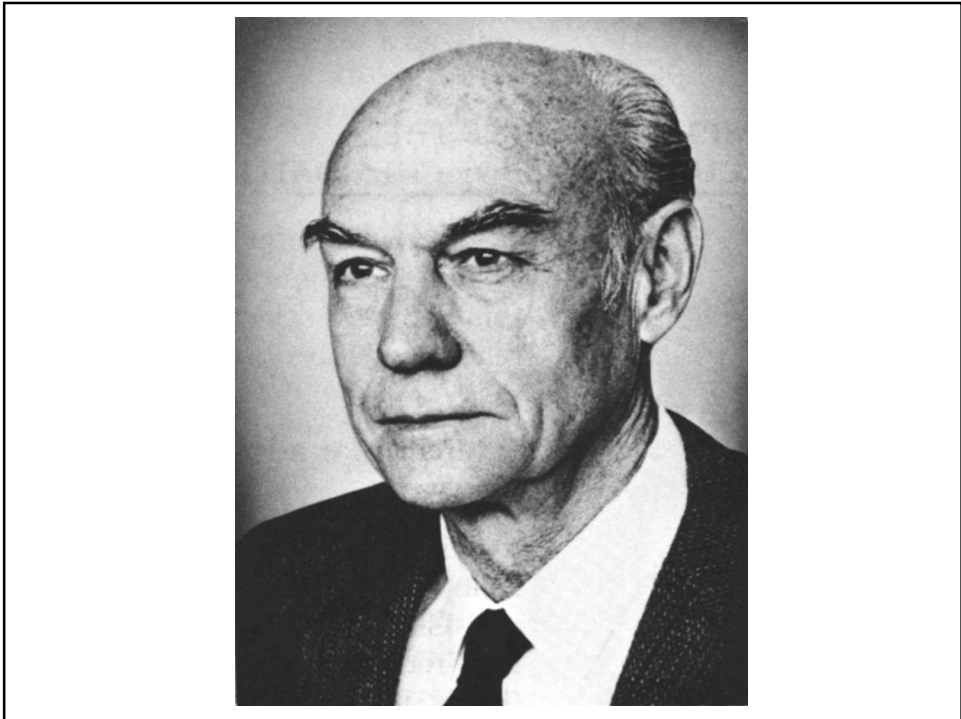
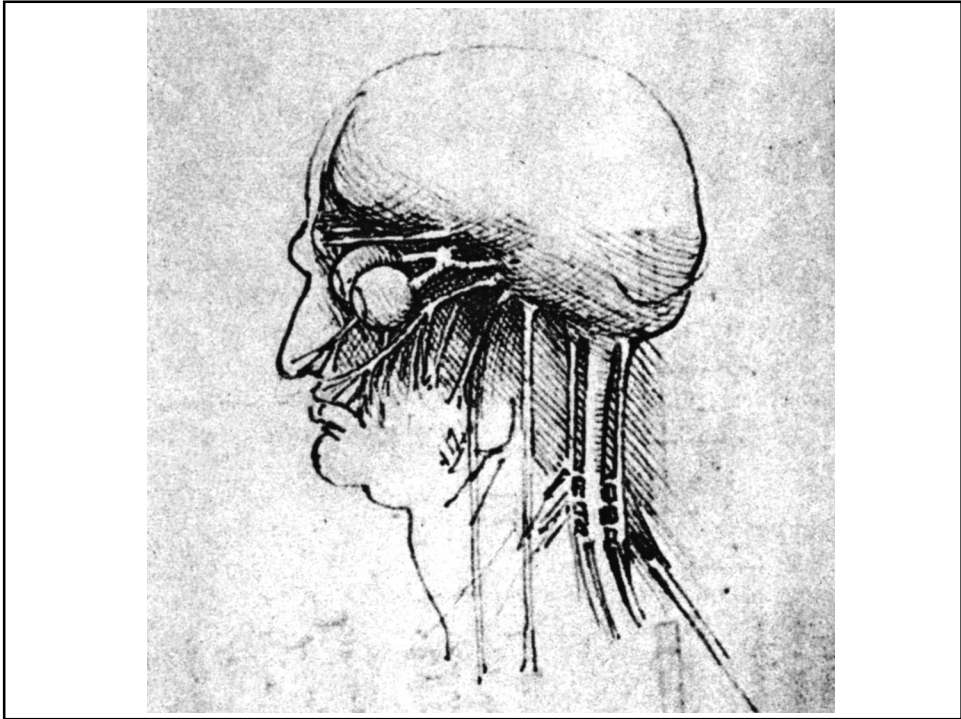

Topographic Wiring of the Eye to the Brain

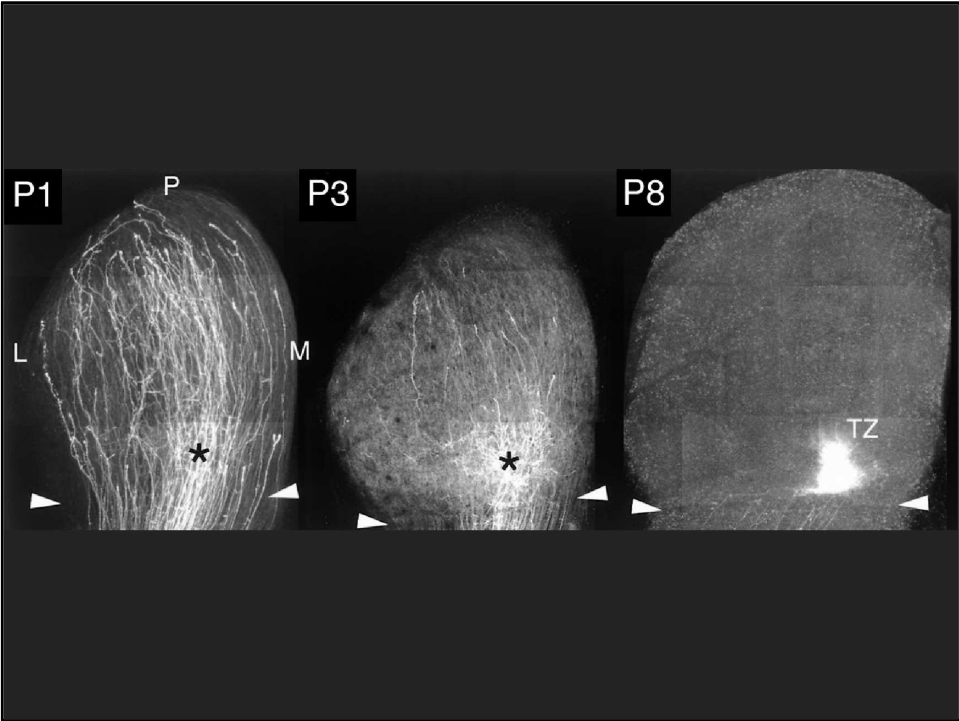
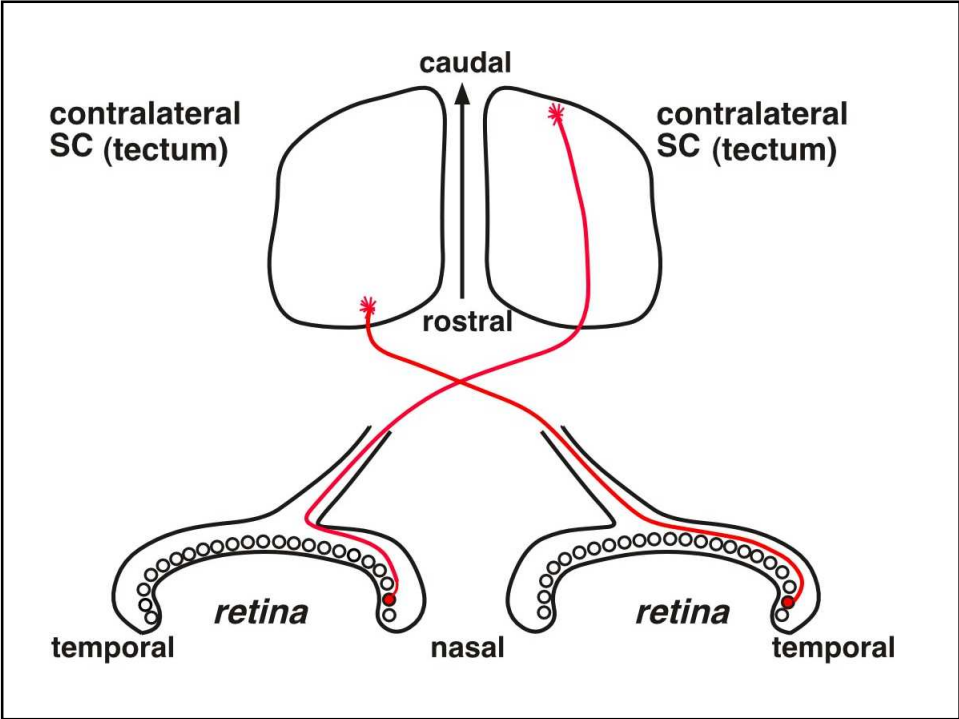

Topographic Wiring of the Eye to the Brain

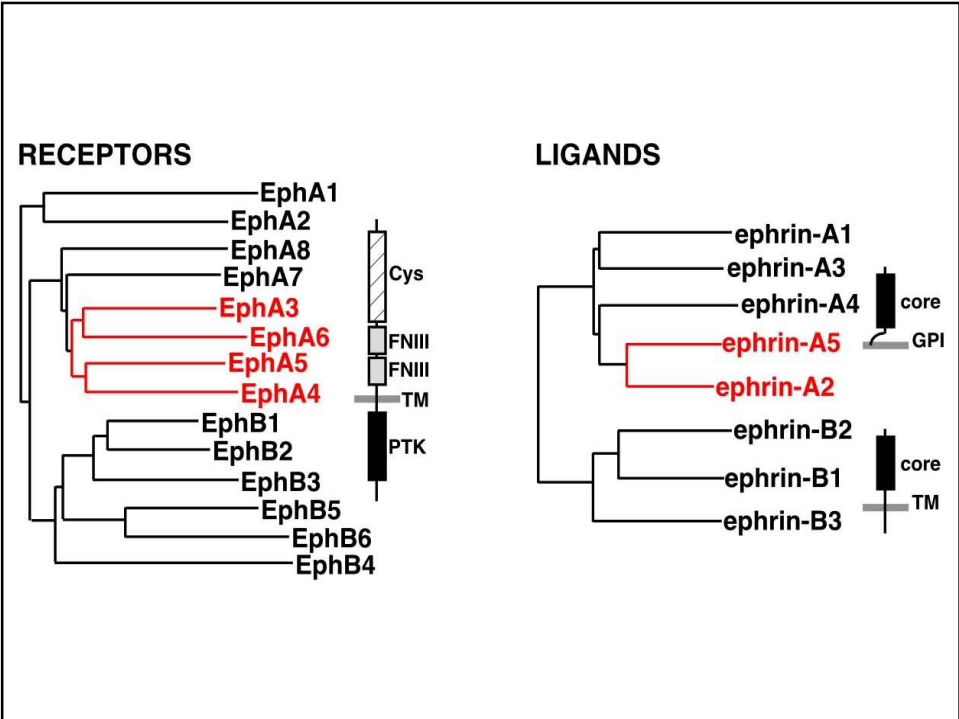
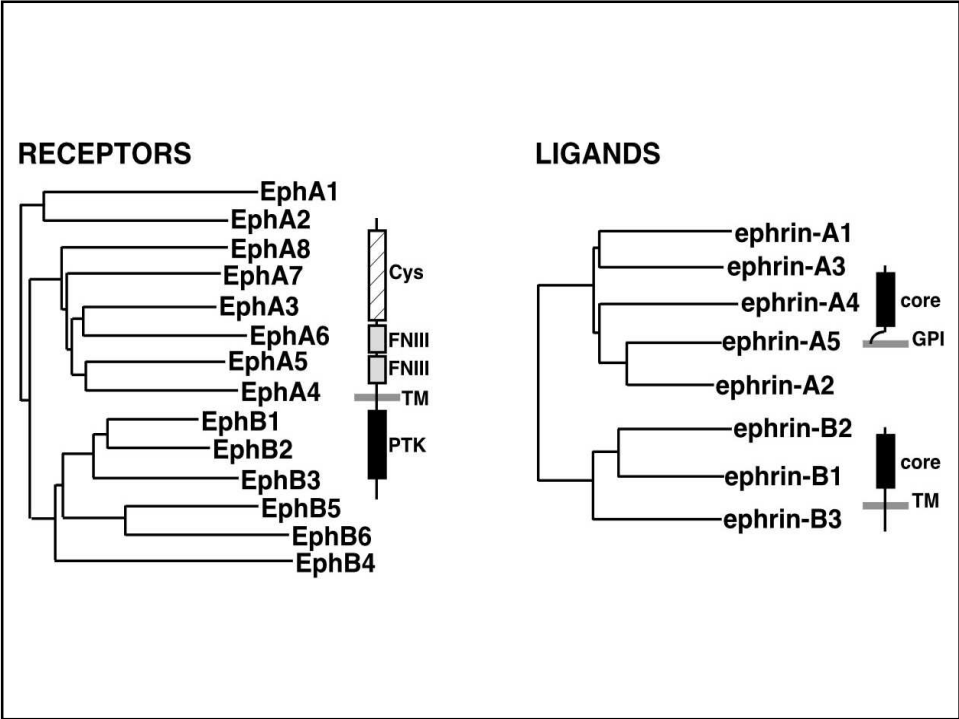

Topographic Wiring of the Eye to the Brain

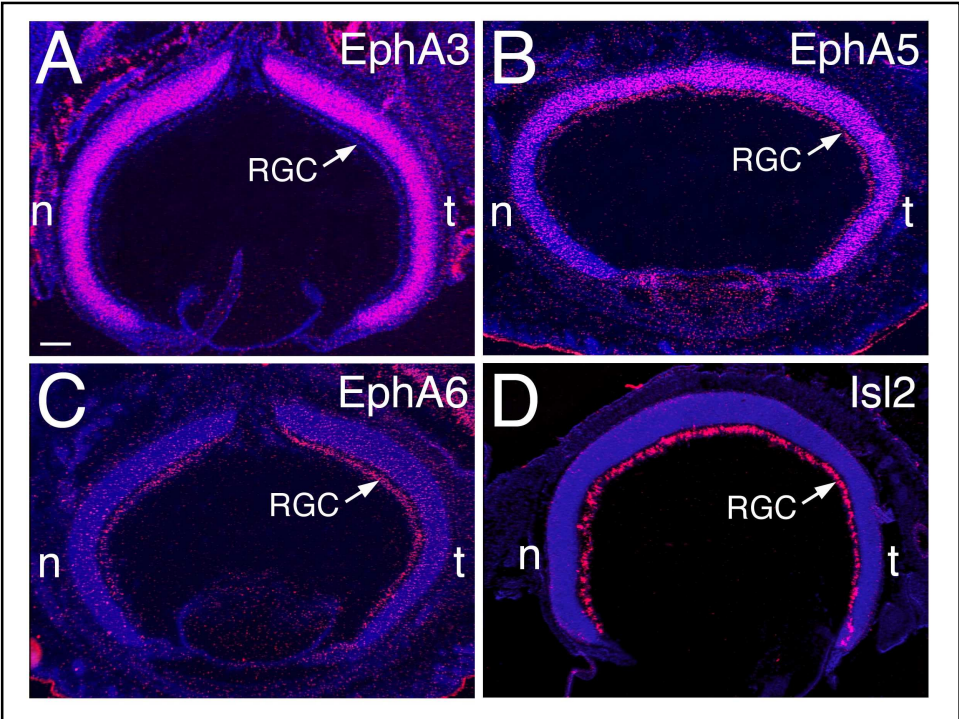
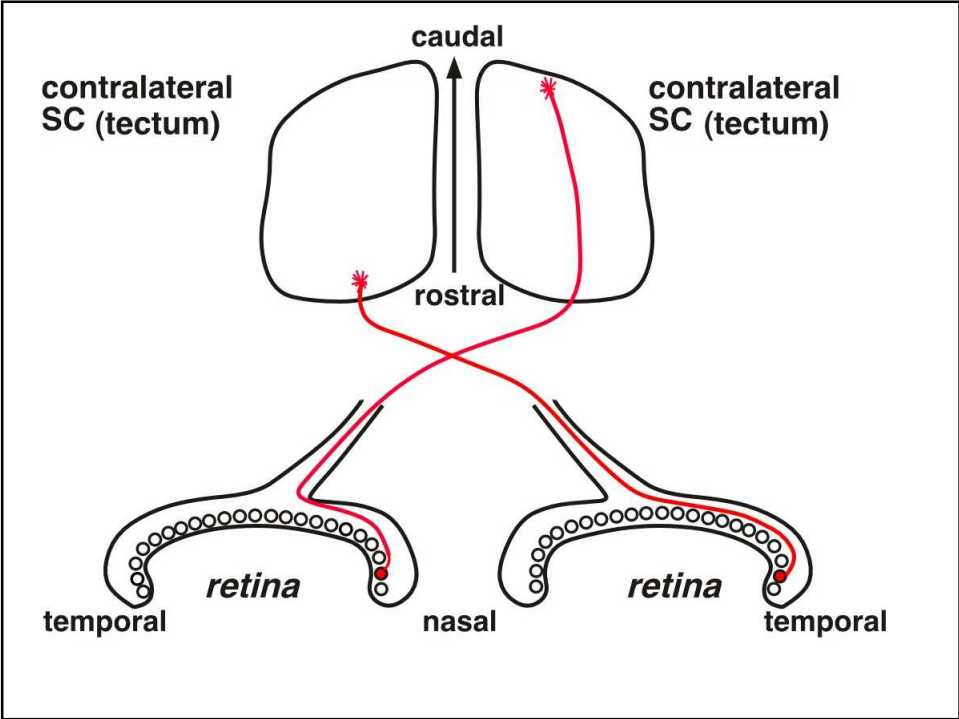

Topographic Wiring of the Eye to the Brain

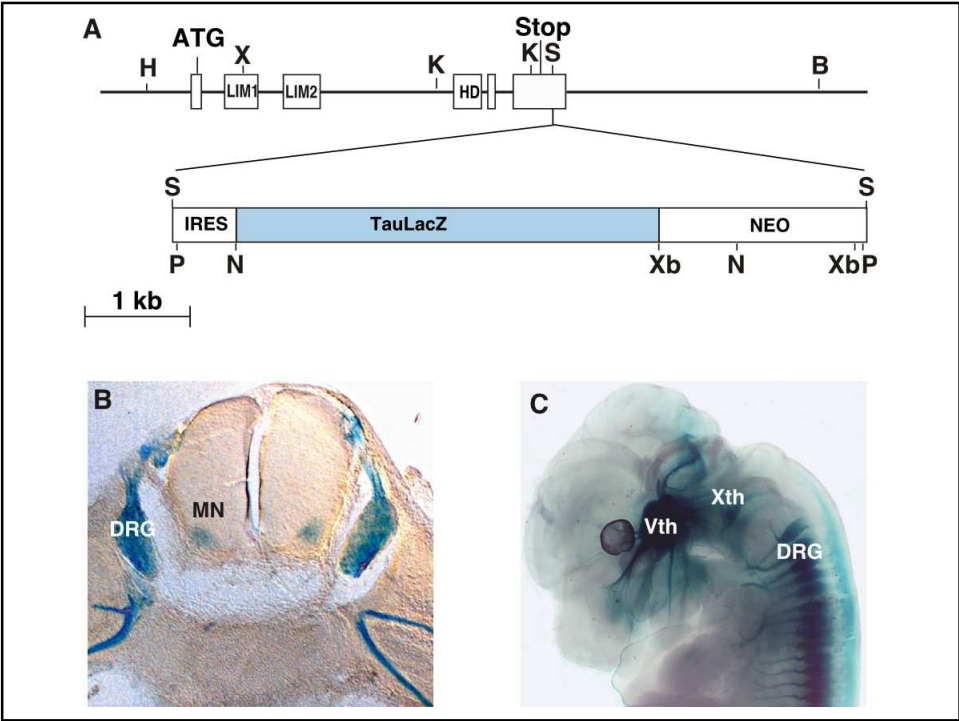
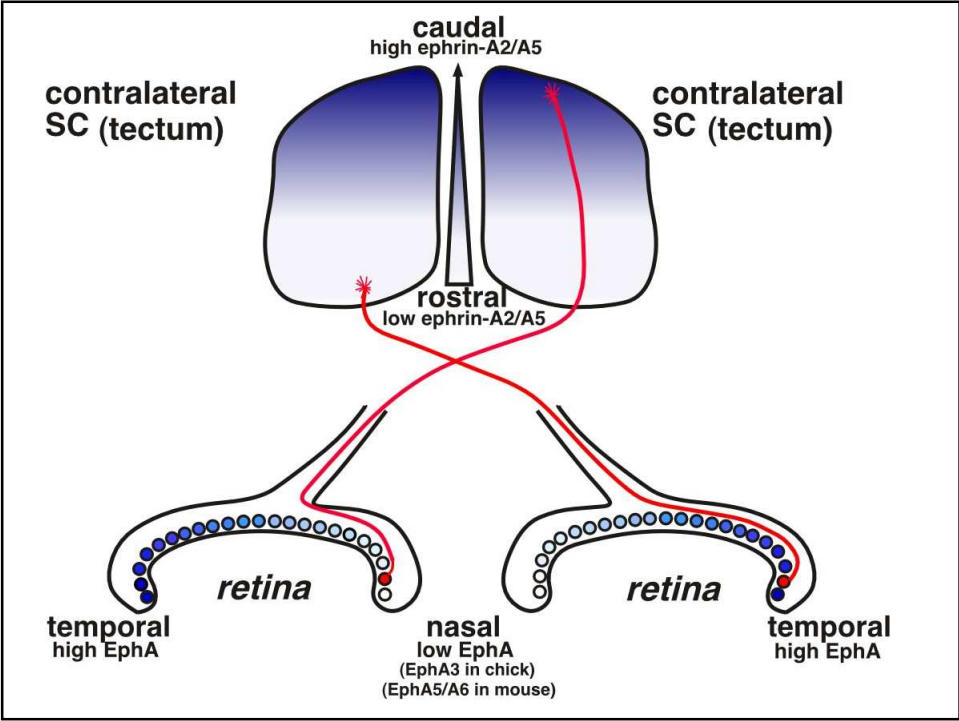

Topographic Wiring of the Eye to the Brain

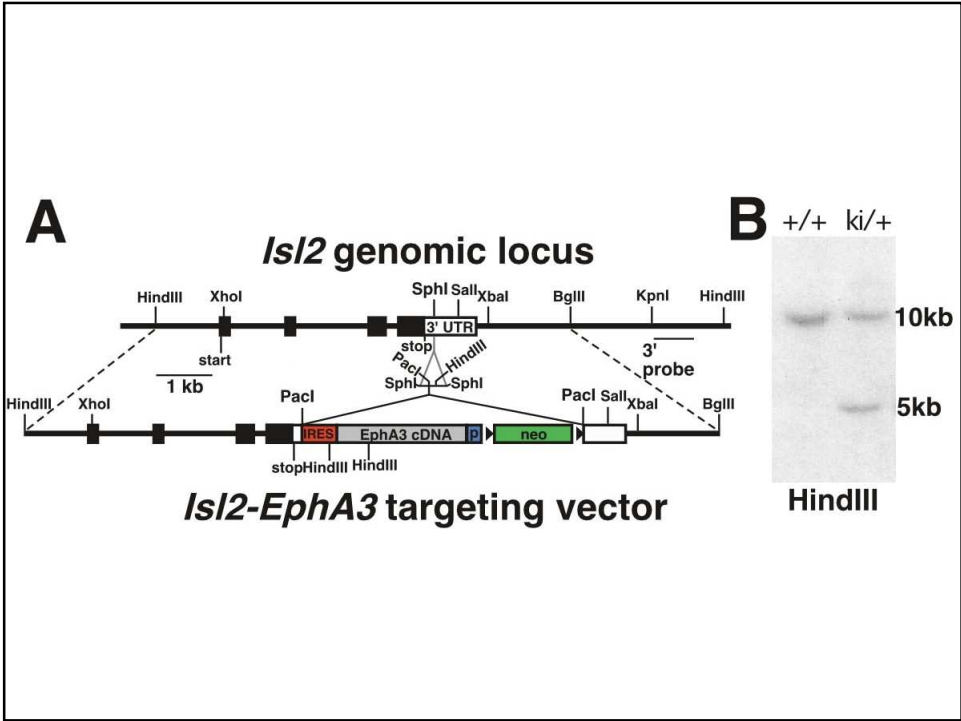
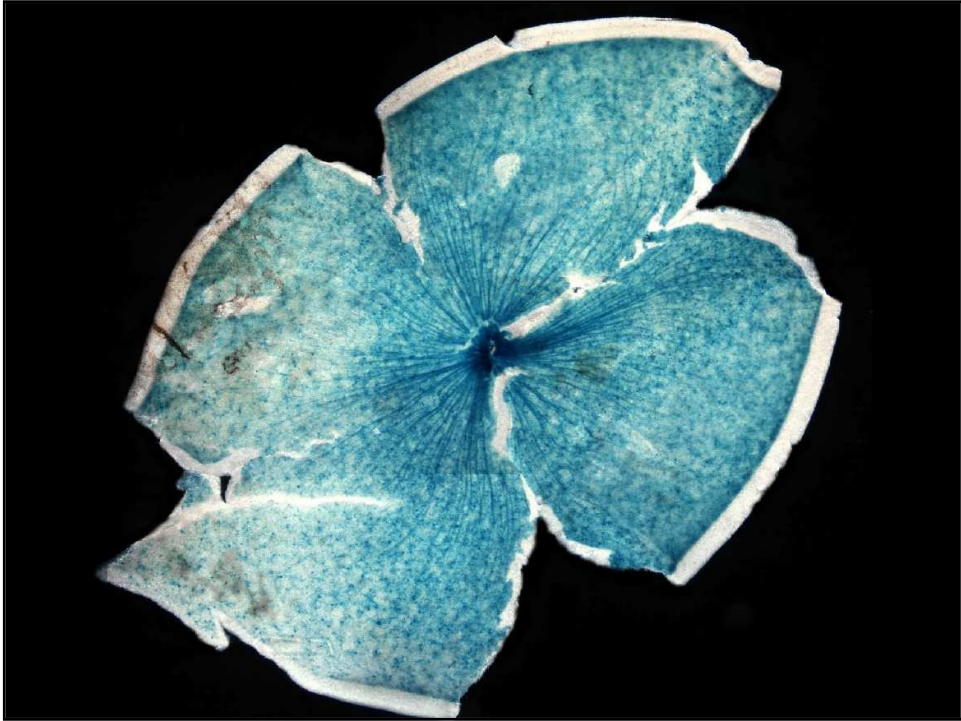

Topographic Wiring of the Eye to the Brain

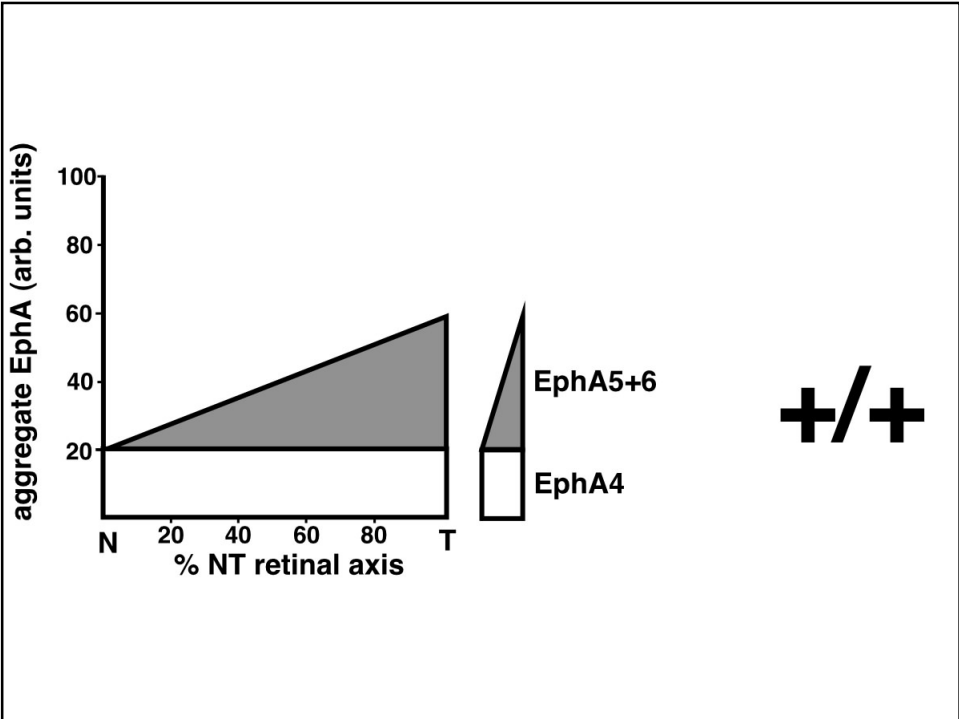
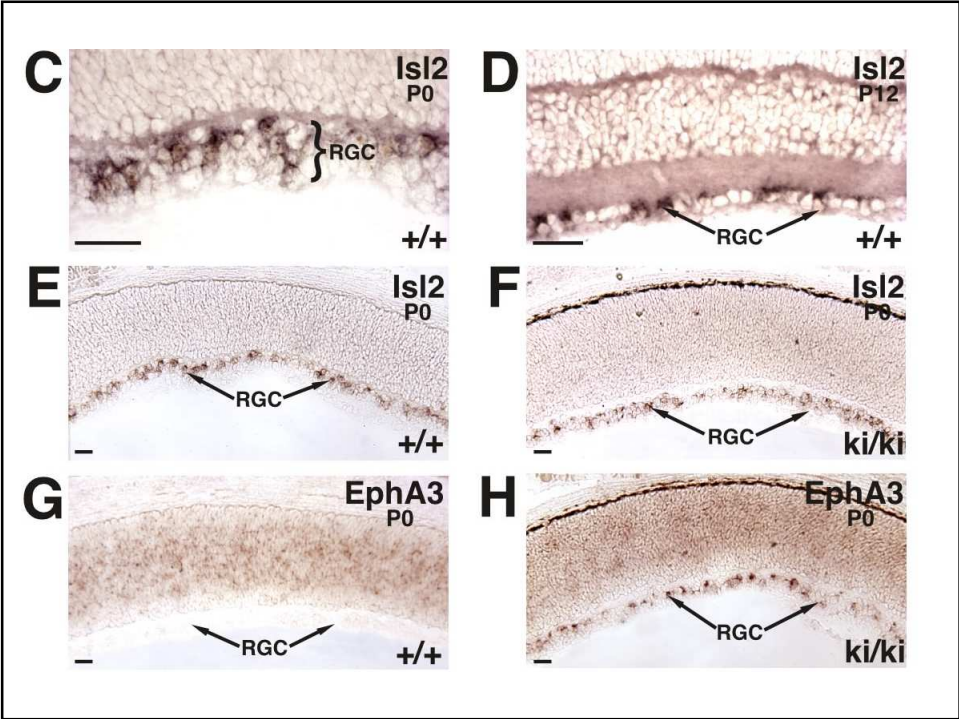

Topographic Wiring of the Eye to the Brain

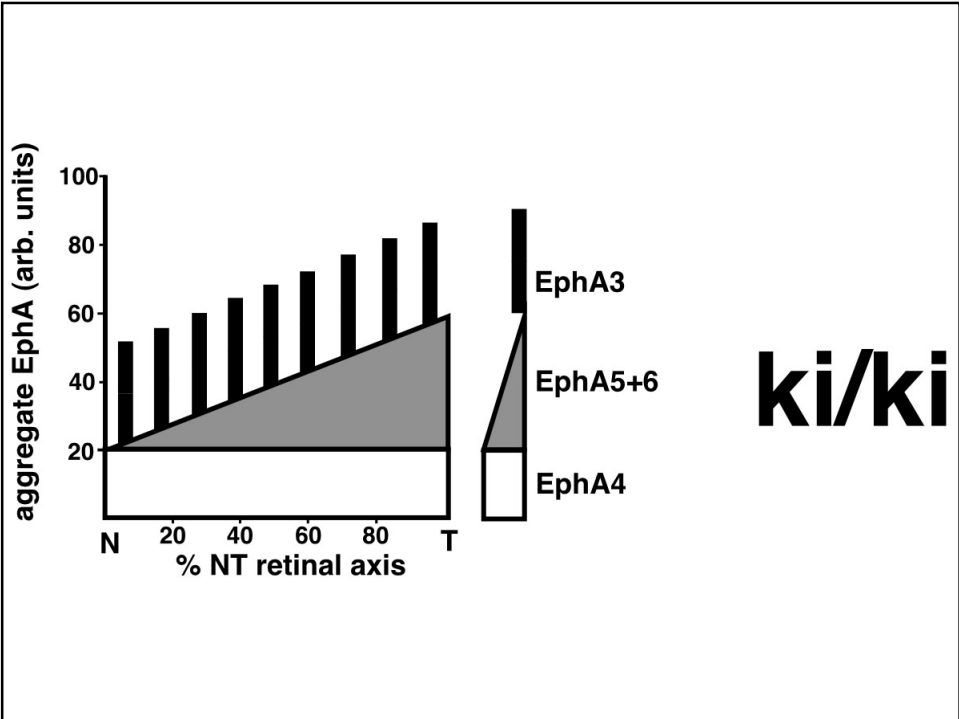
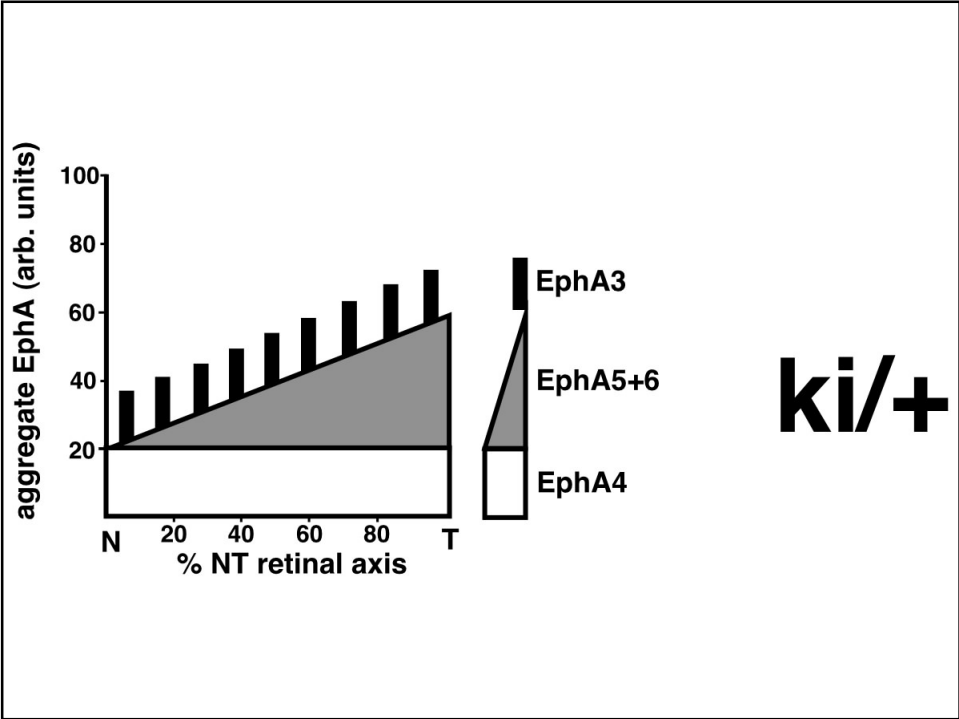

Topographic Wiring of the Eye to the Brain

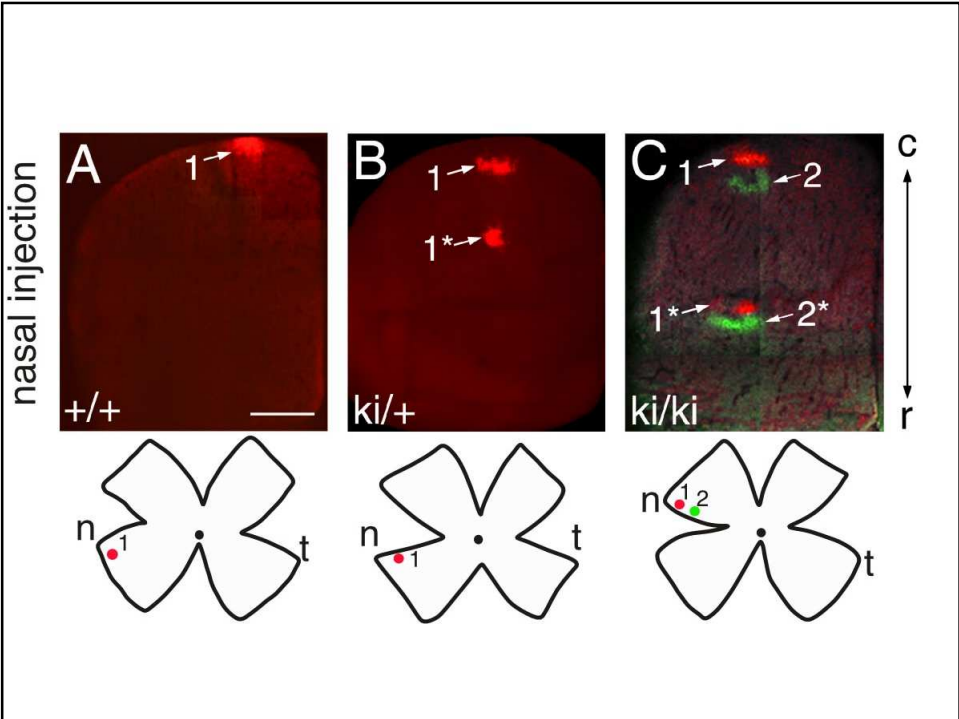
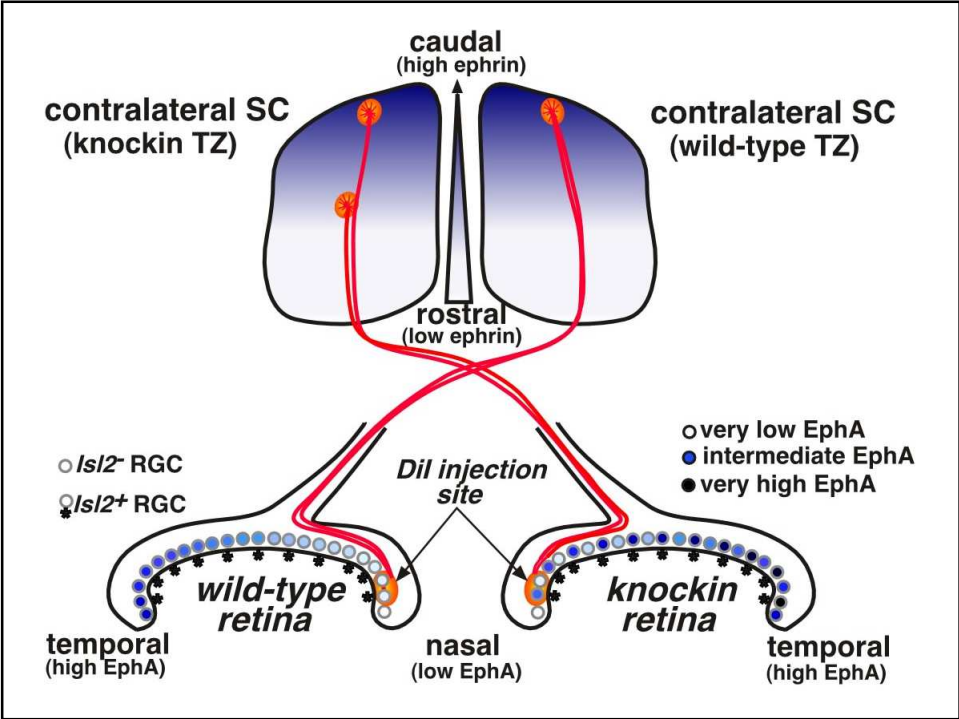

Topographic Wiring of the Eye to the Brain

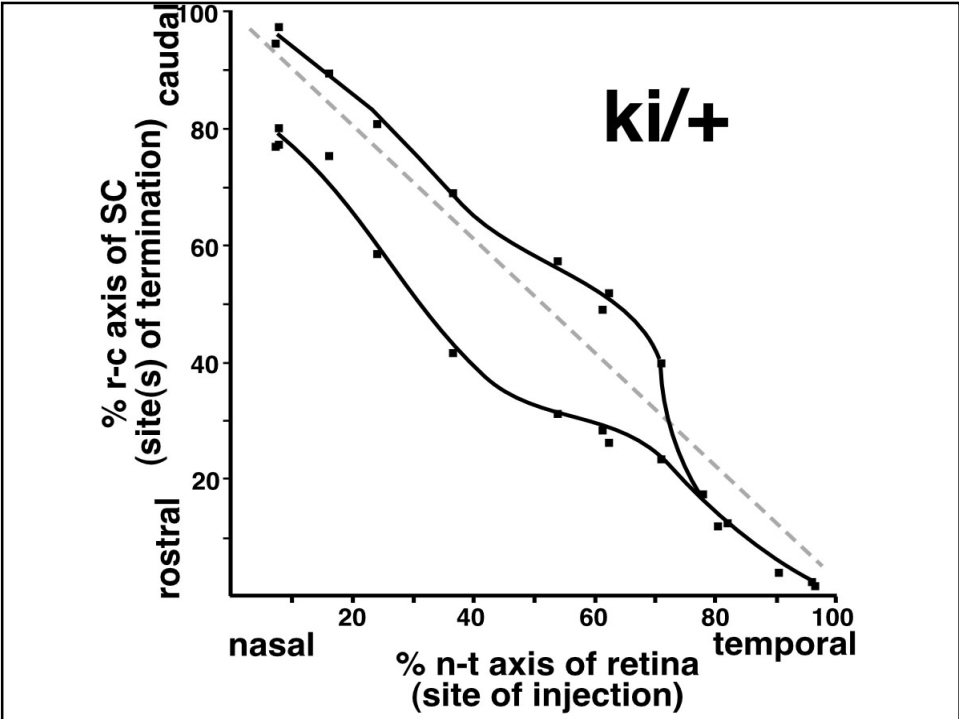
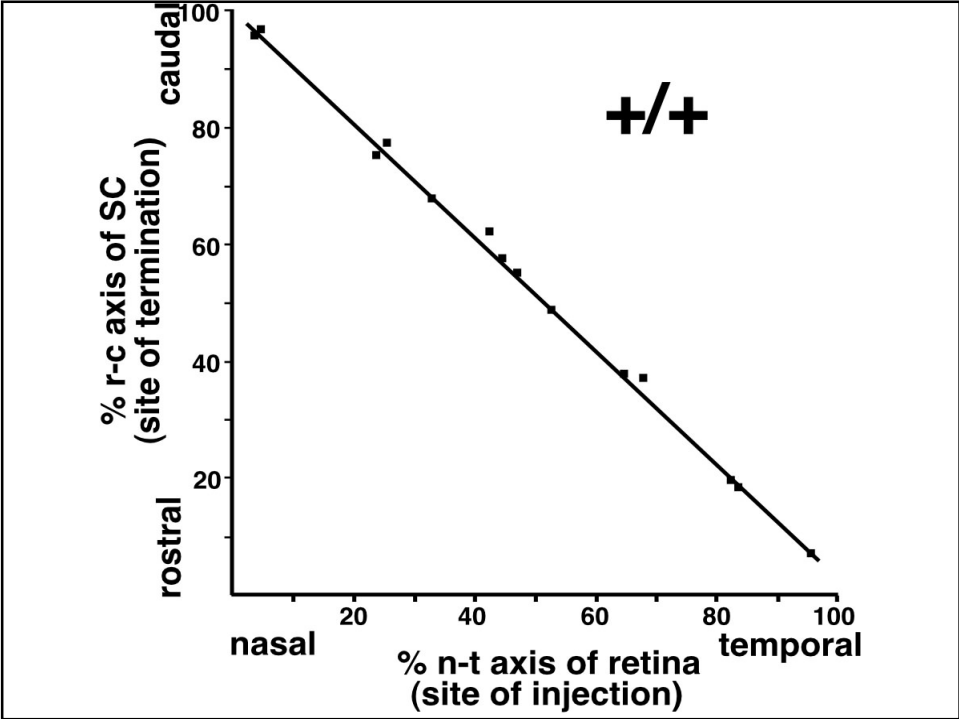

Topographic Wiring of the Eye to the Brain

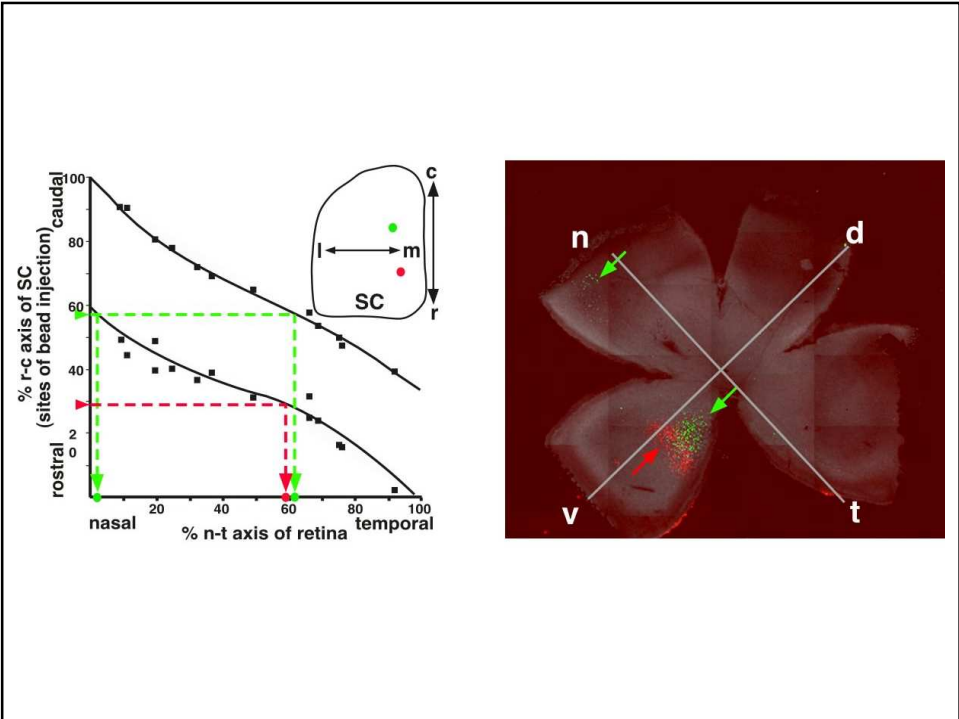
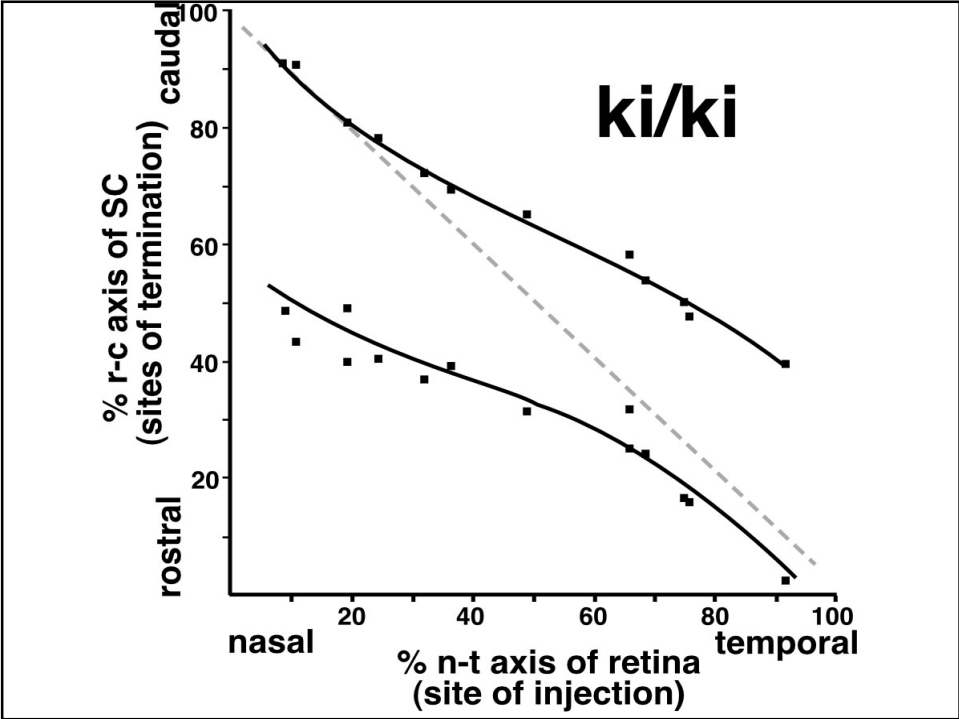

Topographic Wiring of the Eye to the Brain

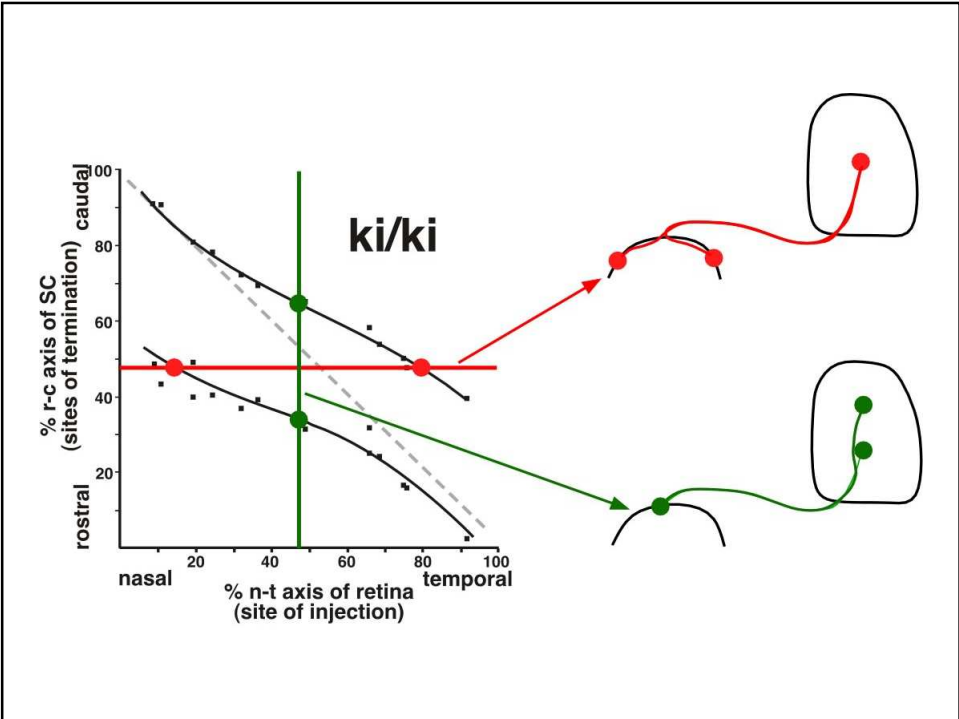
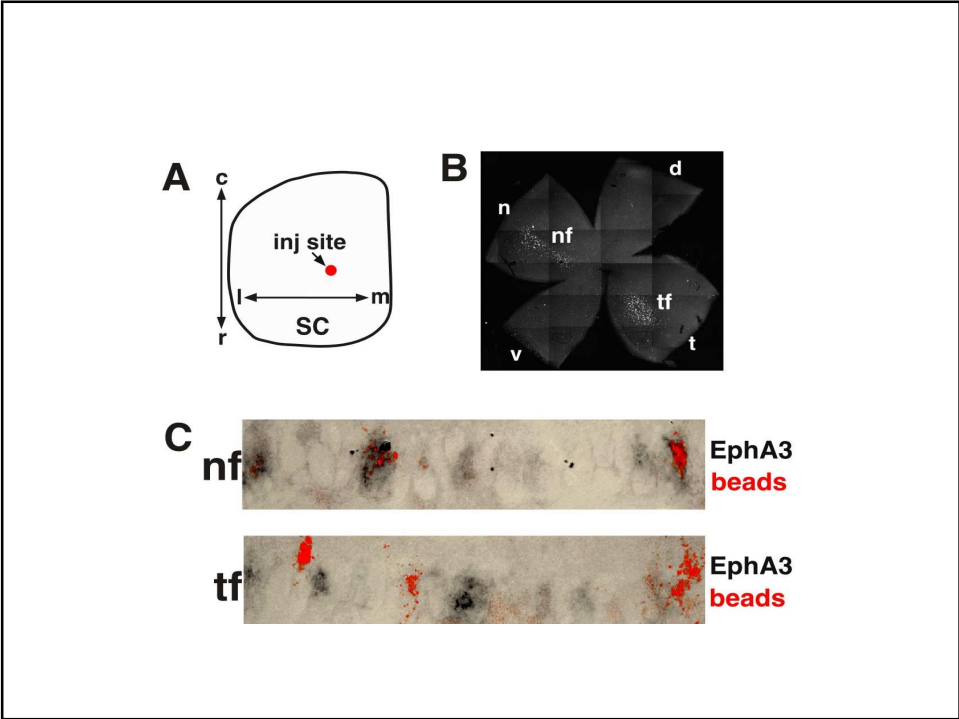

Topographic Wiring of the Eye to the Brain

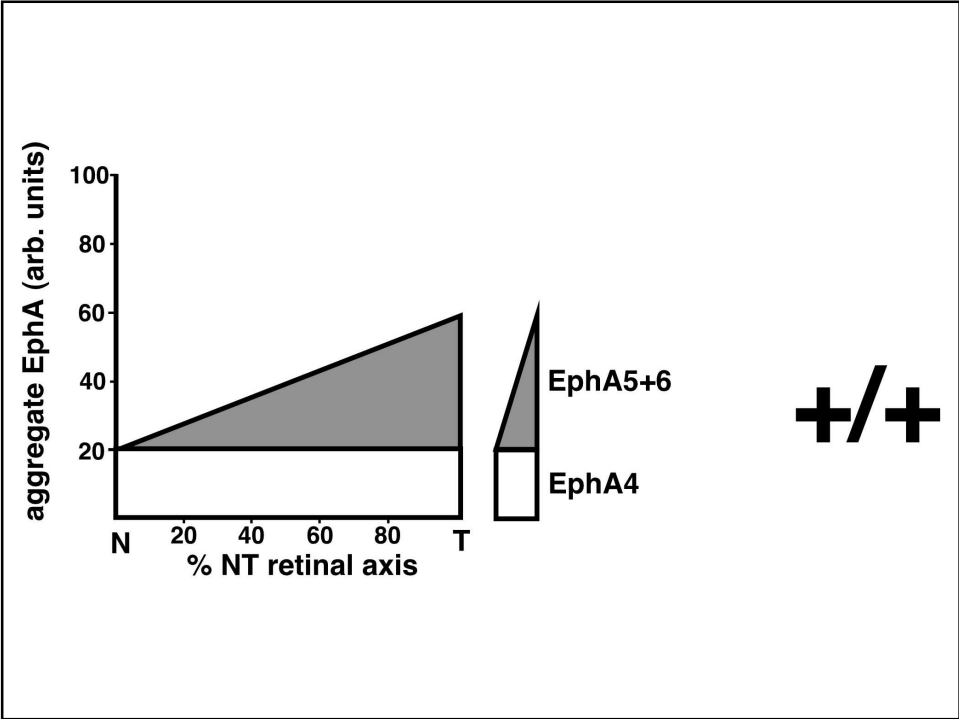

$C = [\text{EphA}_{\text{total}}]$
 $x = \text{NT retinal position}$

$$\frac{dC}{dx} = \alpha C$$

$C = [\text{EphA}_{\text{total}}]$
 $x = \text{NT retinal position}$

$$C(x) = e^{\alpha x}$$

$C = [\text{EphA}_{\text{total}}]$
 $x = \text{NT retinal position}$

$$C(x) = e^{\alpha x} + \beta A_4$$

Topographic Wiring of the Eye to the Brain

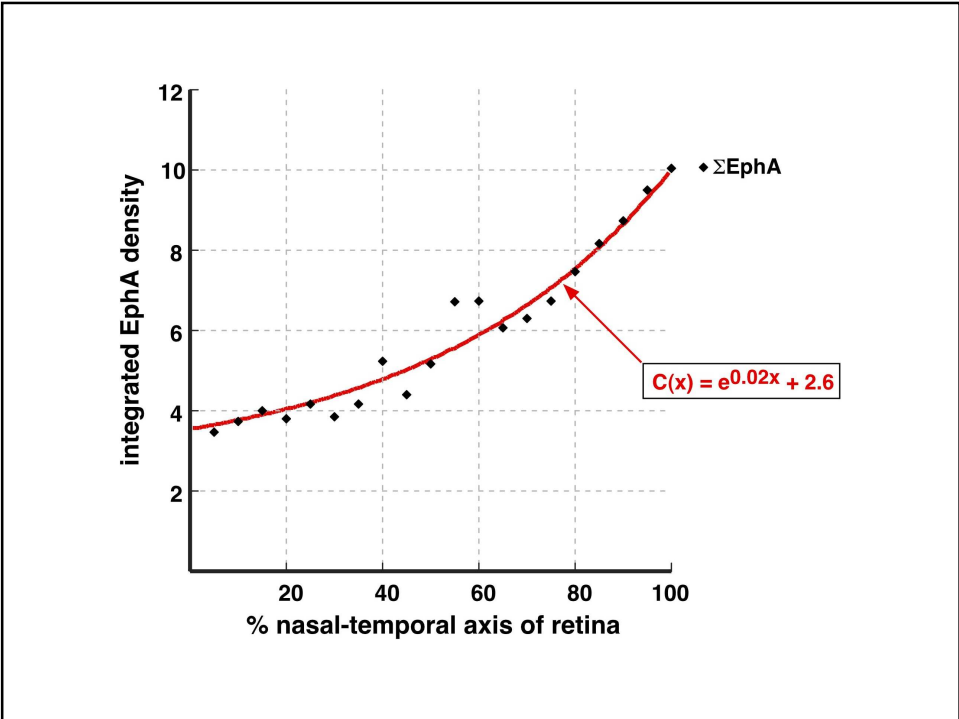
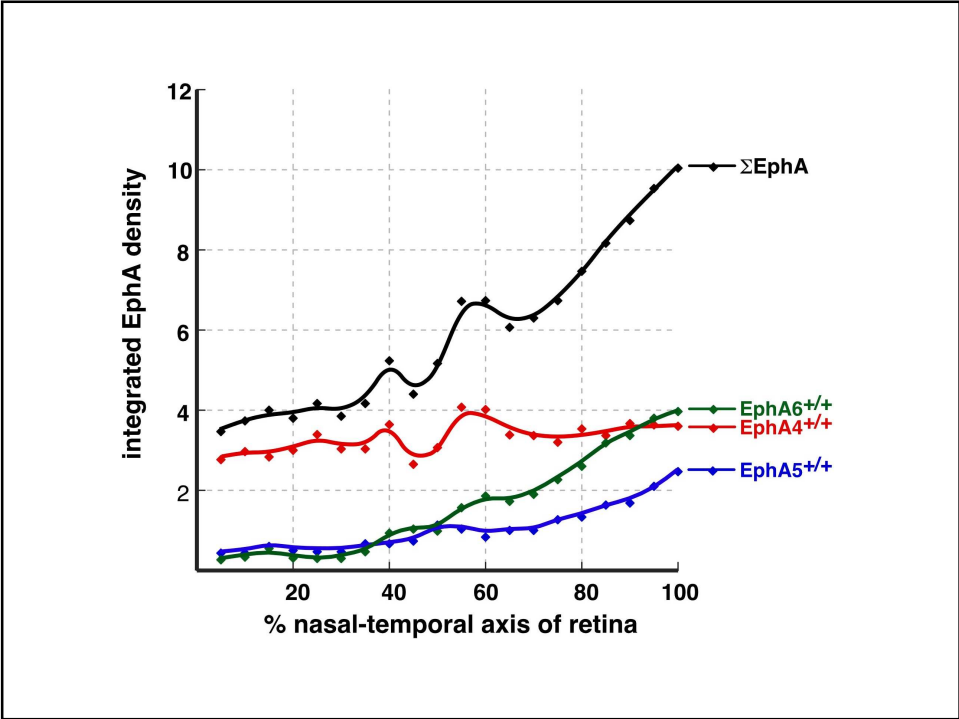

Topographic Wiring of the Eye to the Brain

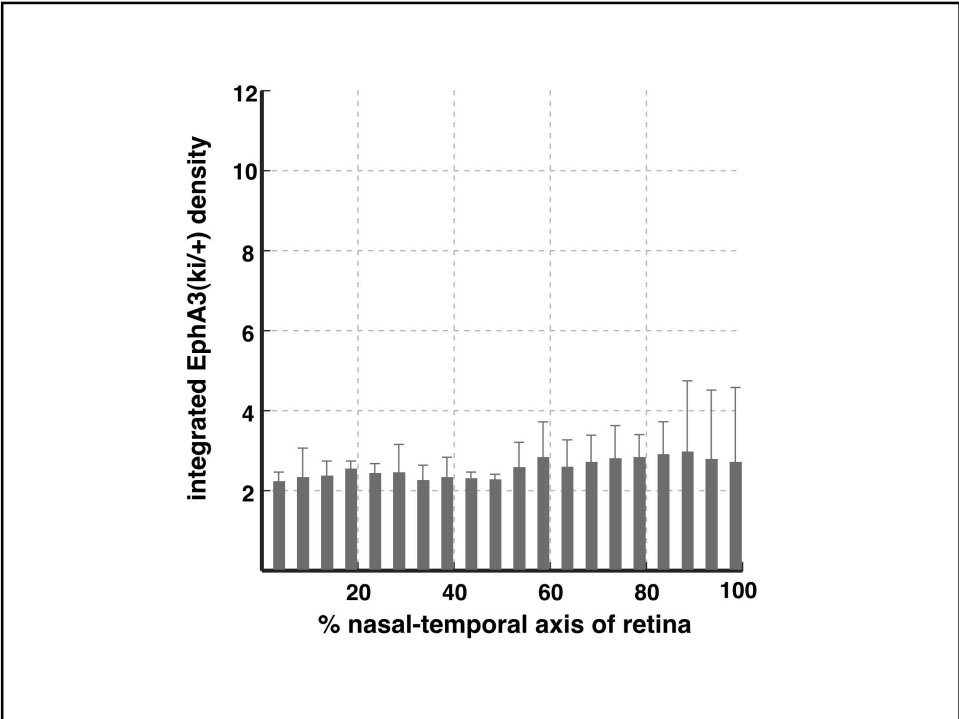
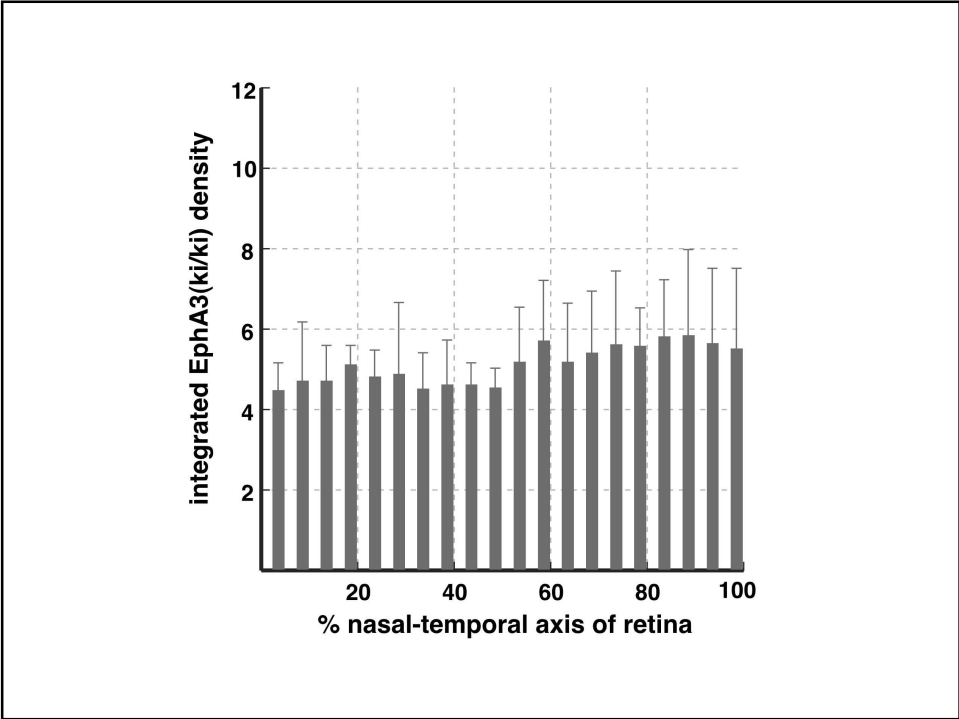

Topographic Wiring of the Eye to the Brain

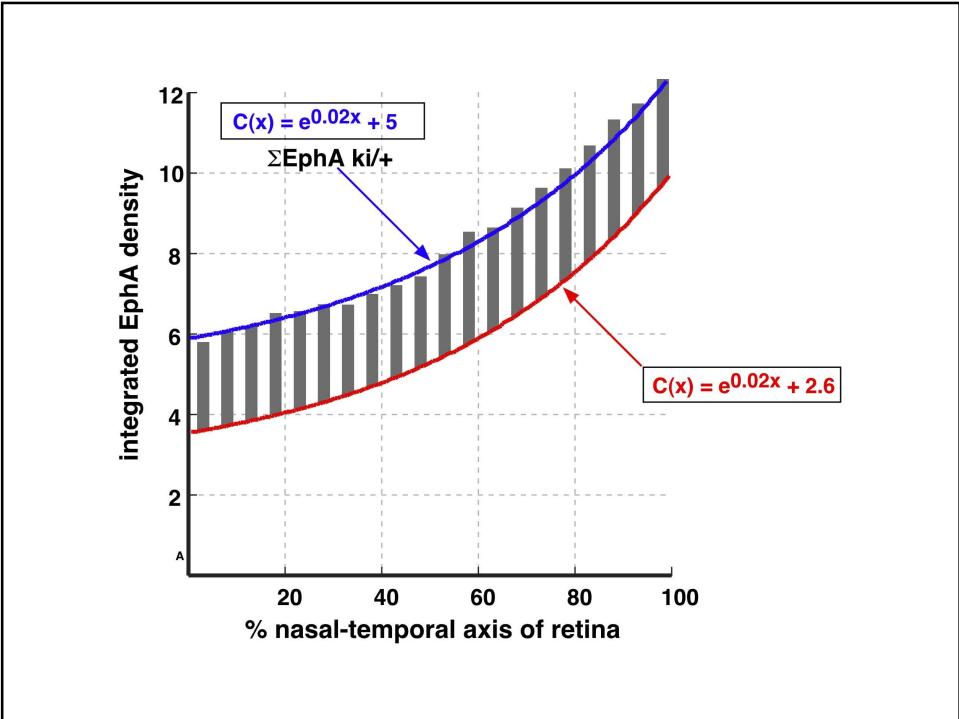
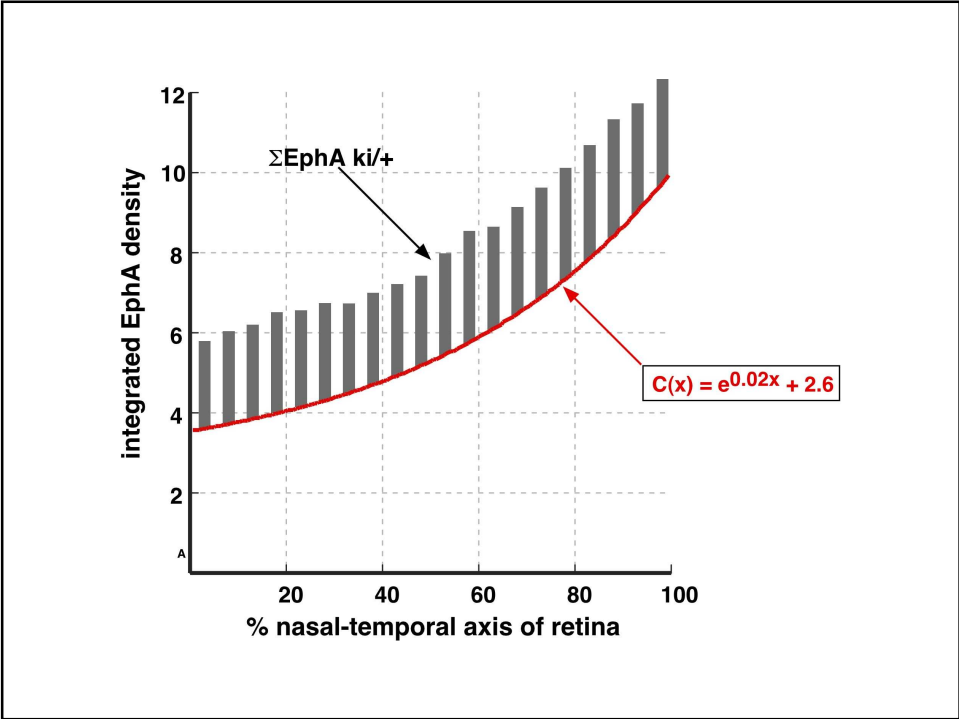

Topographic Wiring of the Eye to the Brain

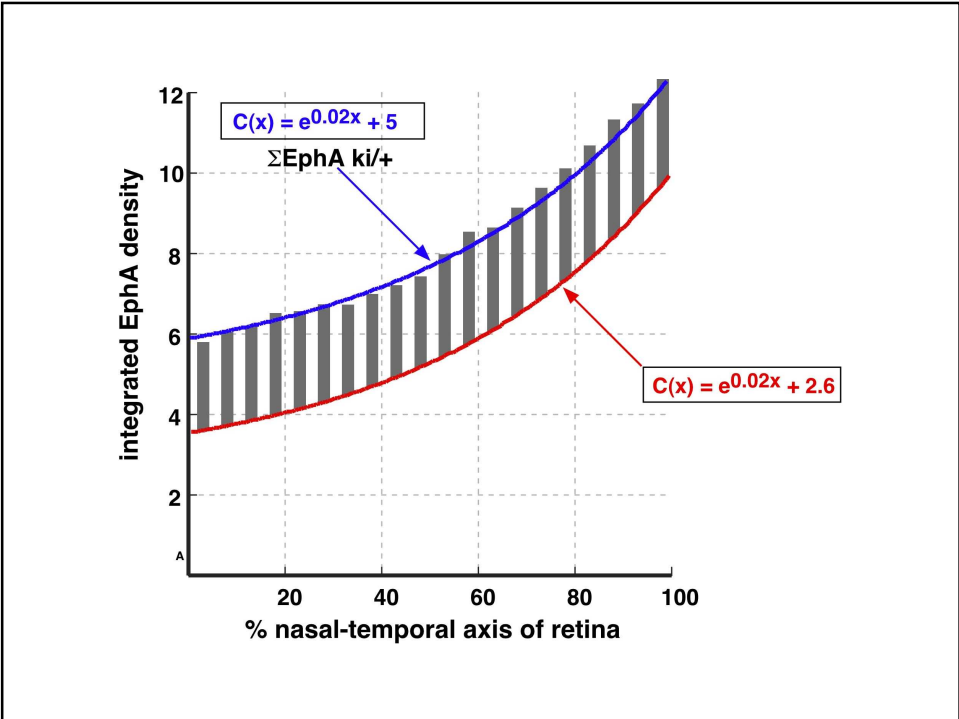
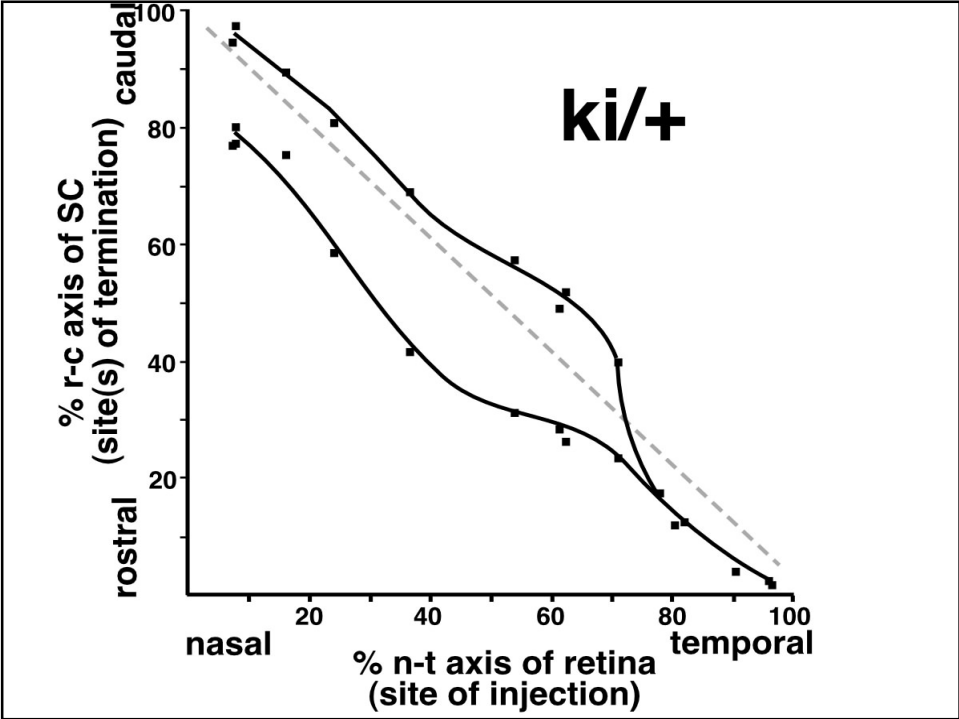

Topographic Wiring of the Eye to the Brain

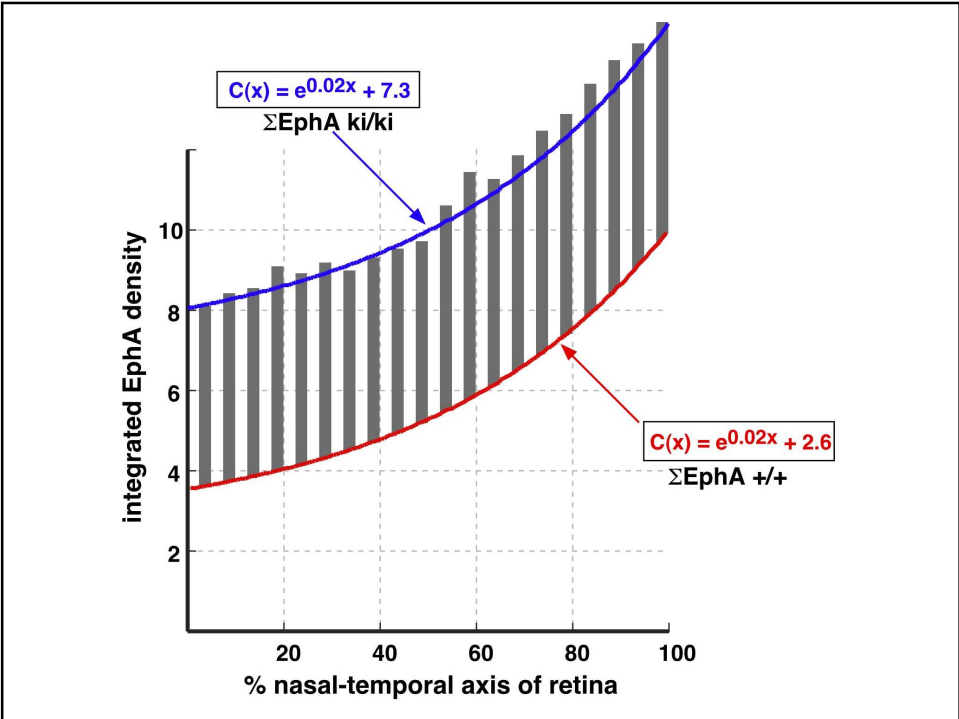
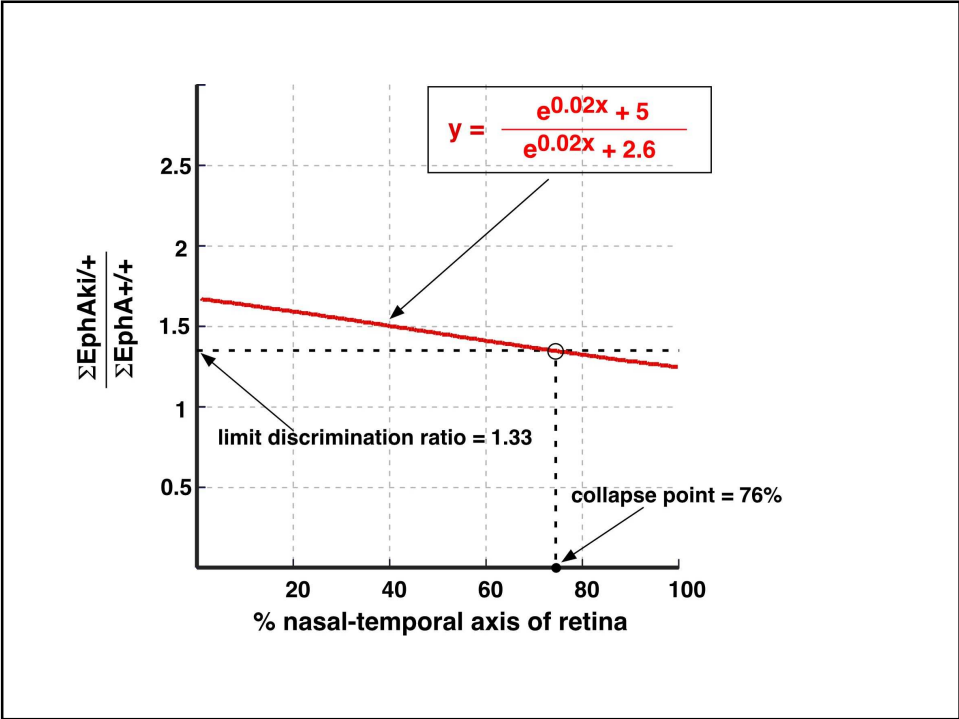

Topographic Wiring of the Eye to the Brain

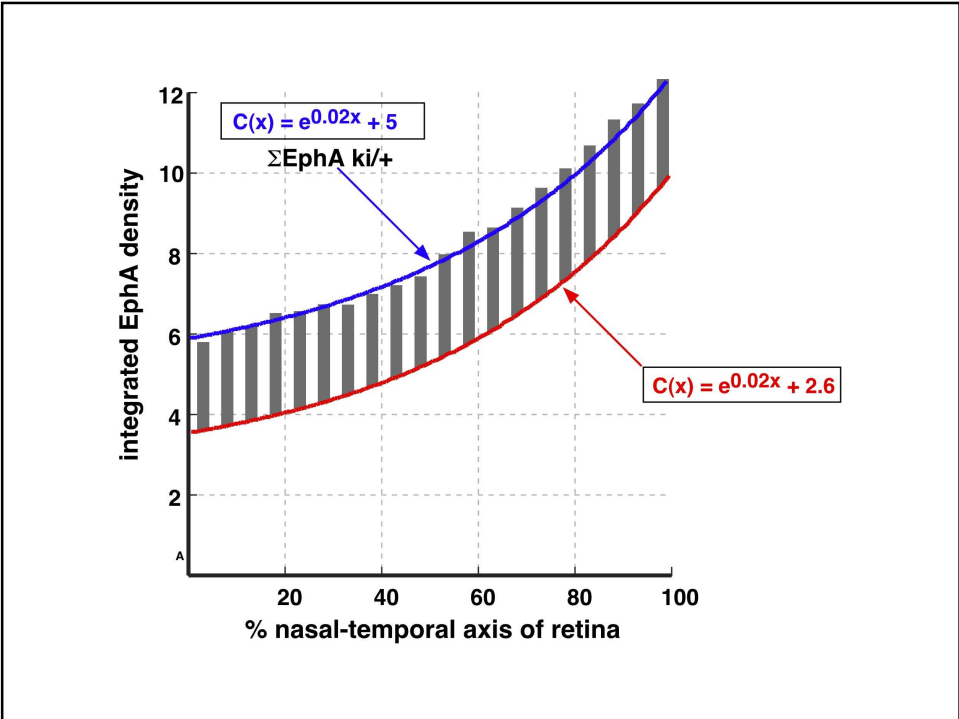
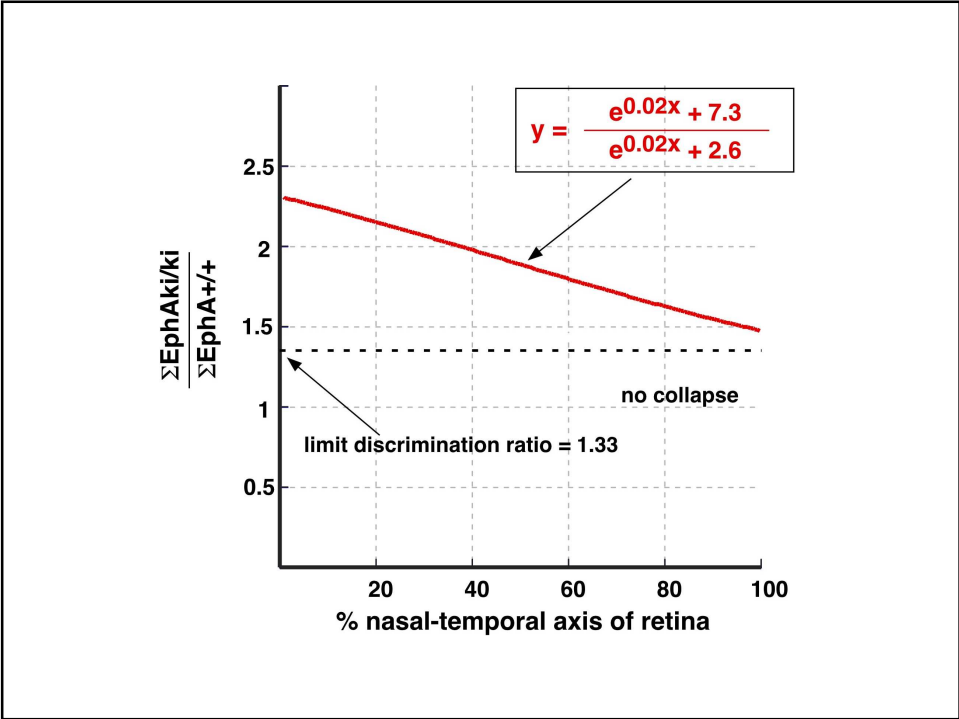

Topographic Wiring of the Eye to the Brain

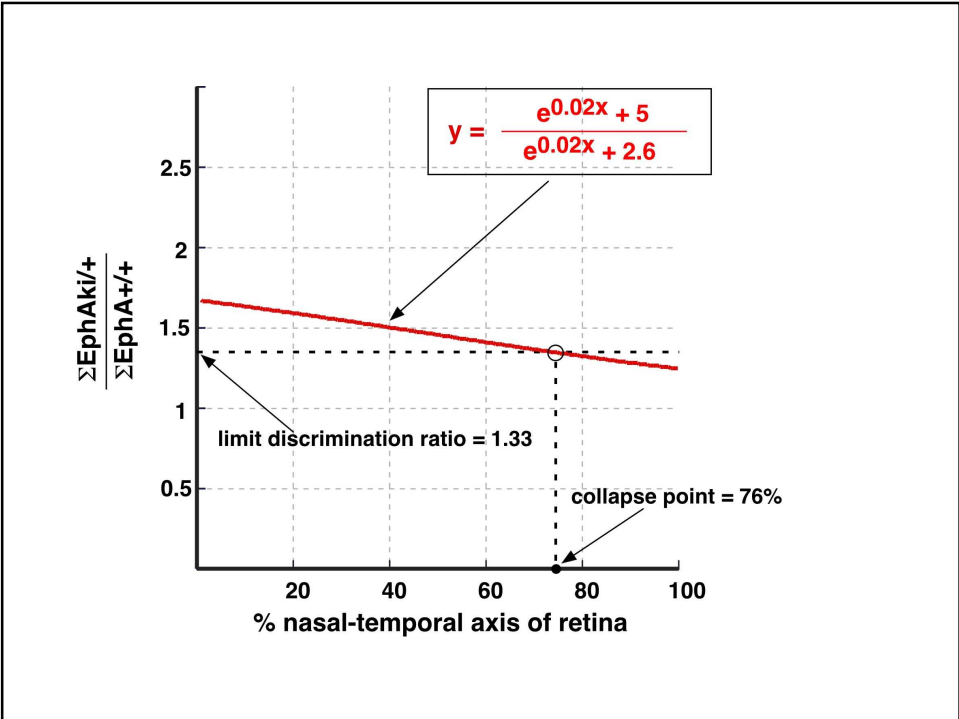
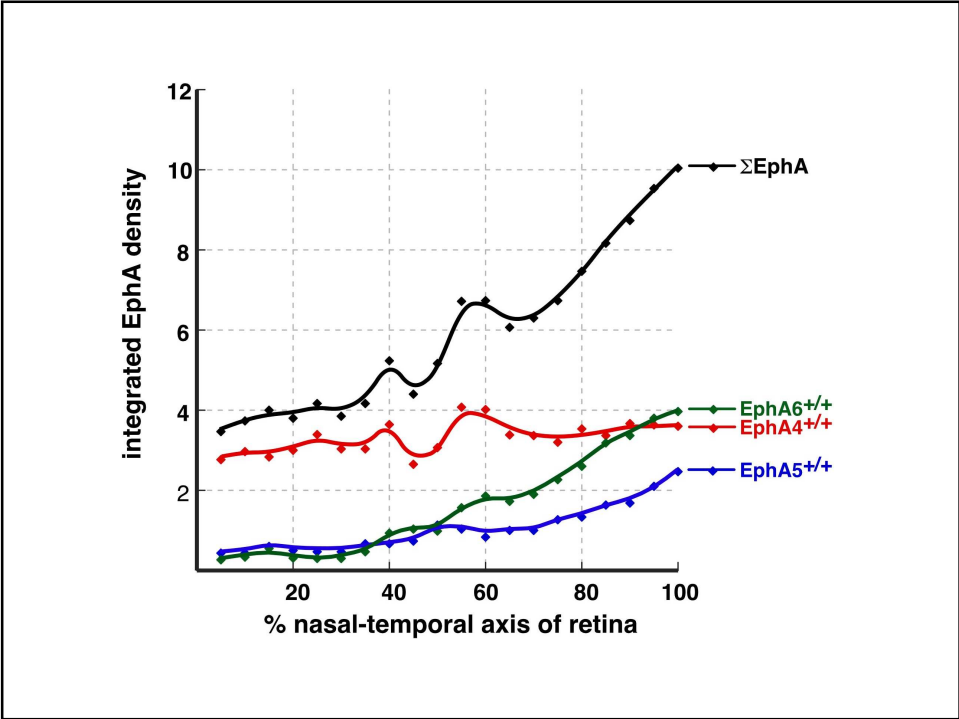

Topographic Wiring of the Eye to the Brain

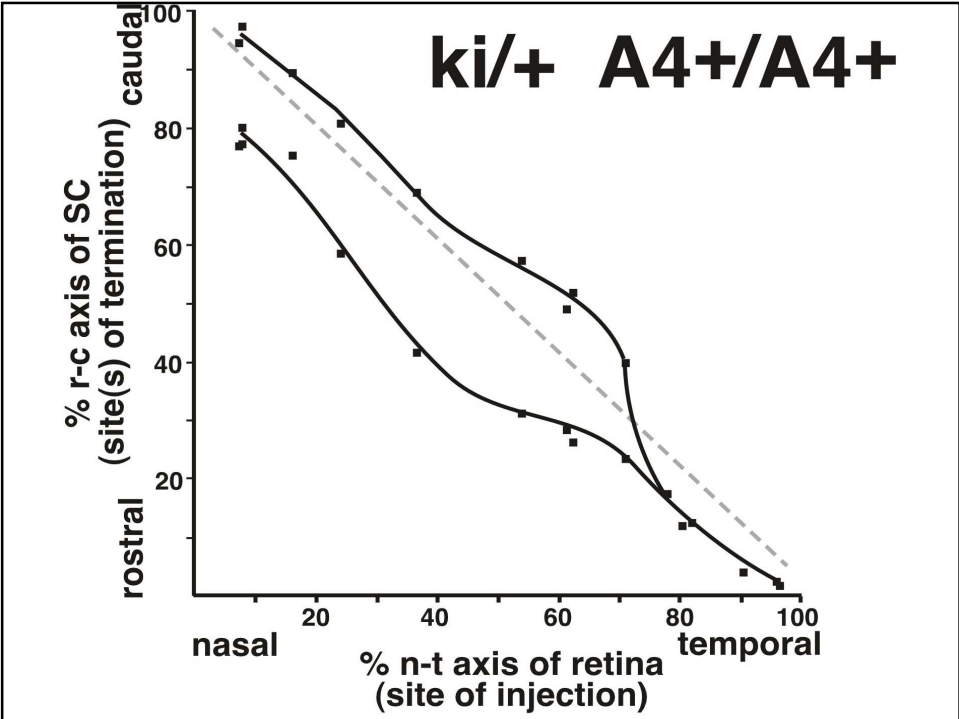
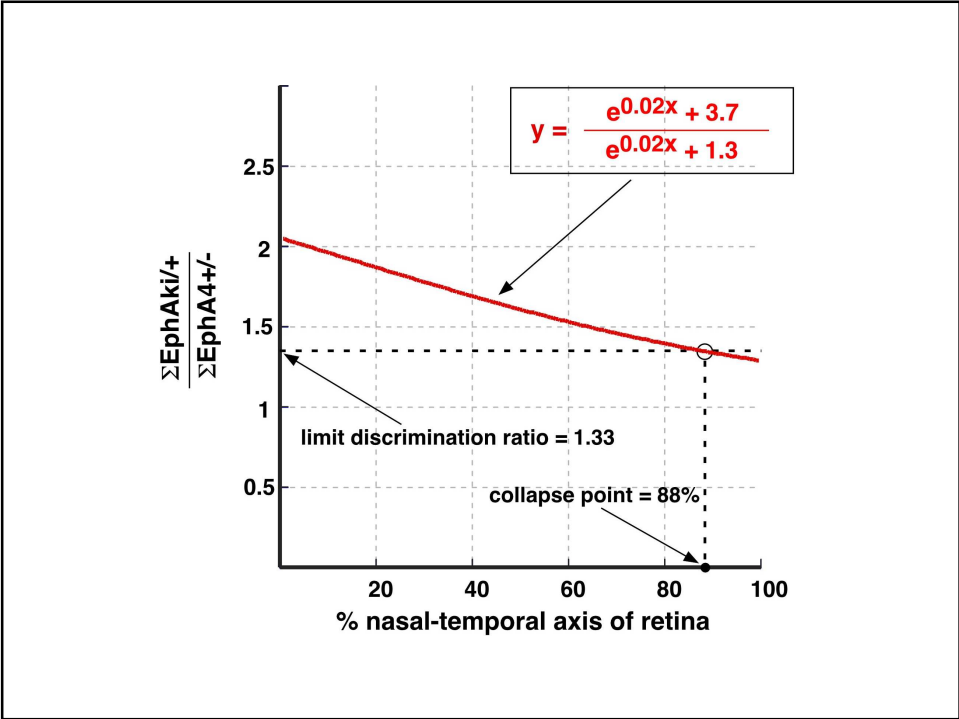

Topographic Wiring of the Eye to the Brain

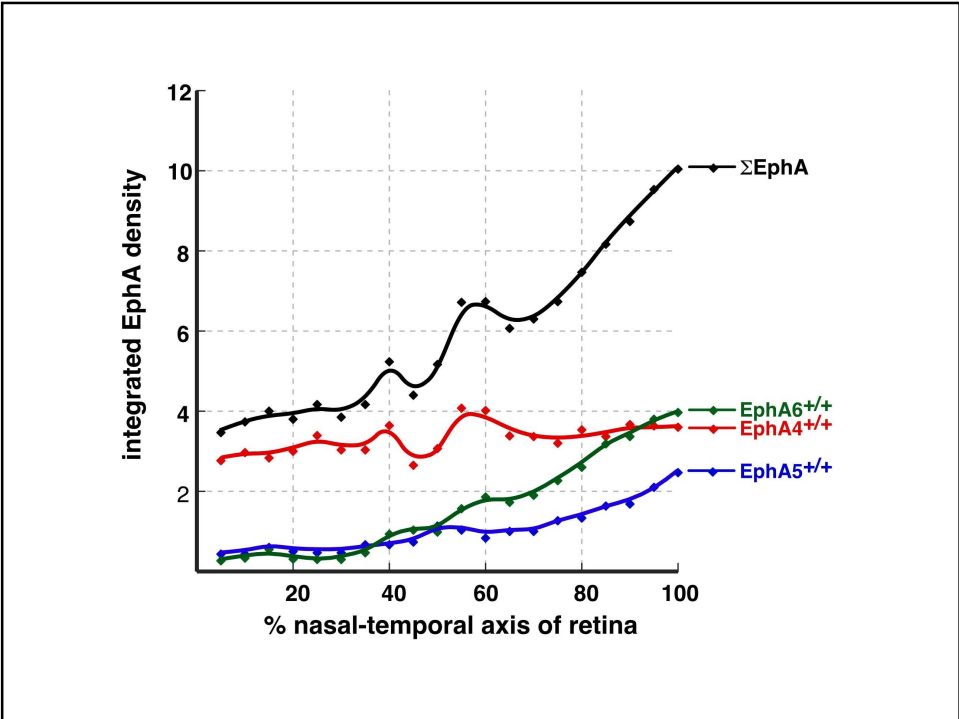
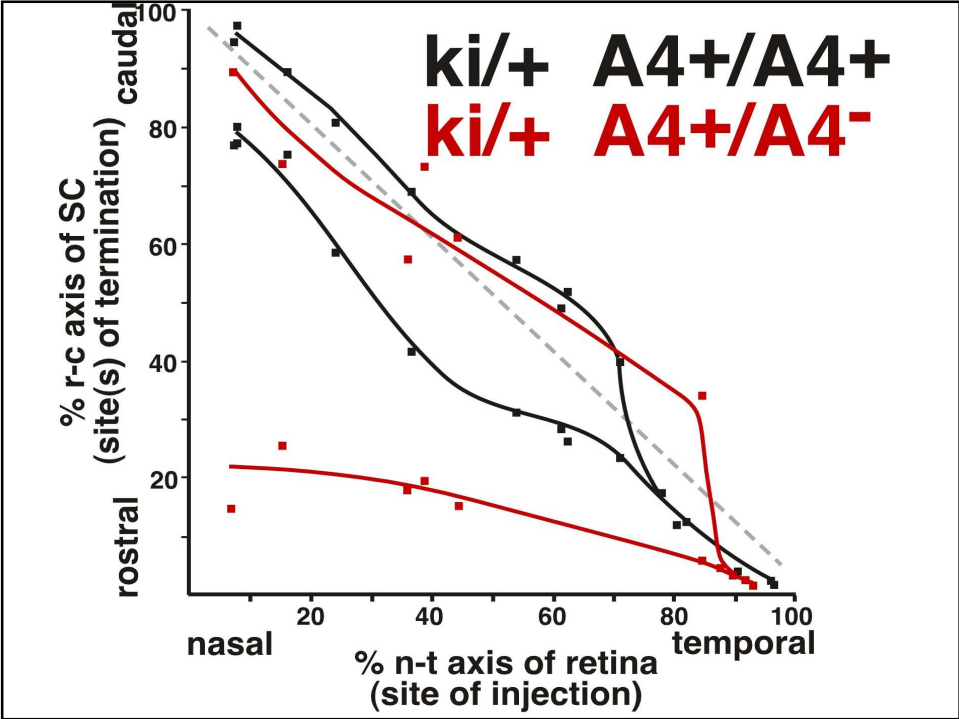

Topographic Wiring of the Eye to the Brain

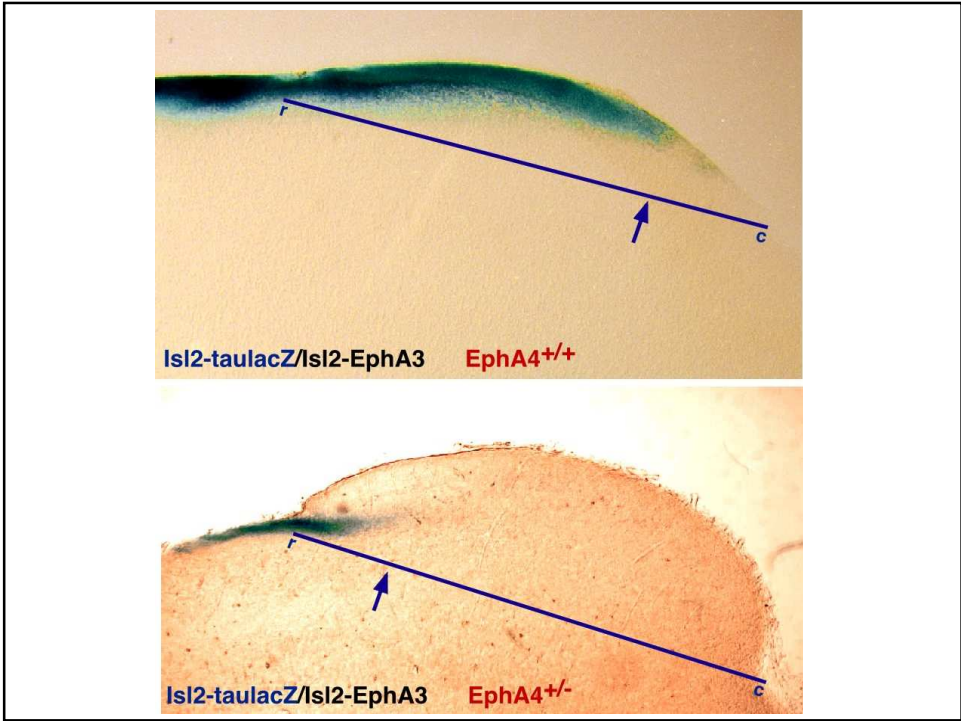
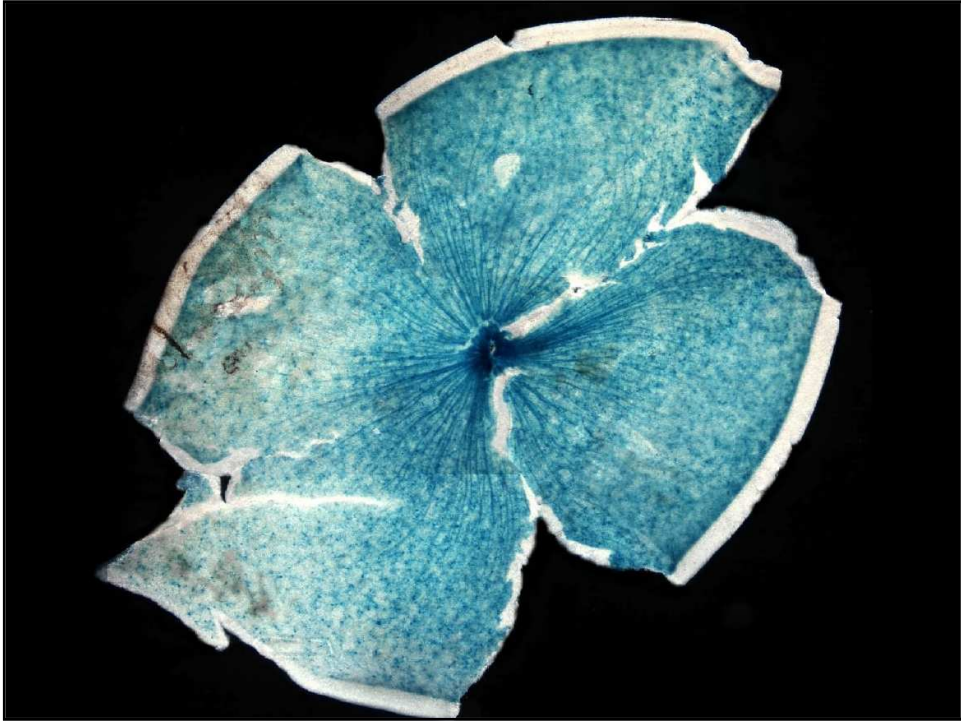

Topographic Wiring of the Eye to the Brain

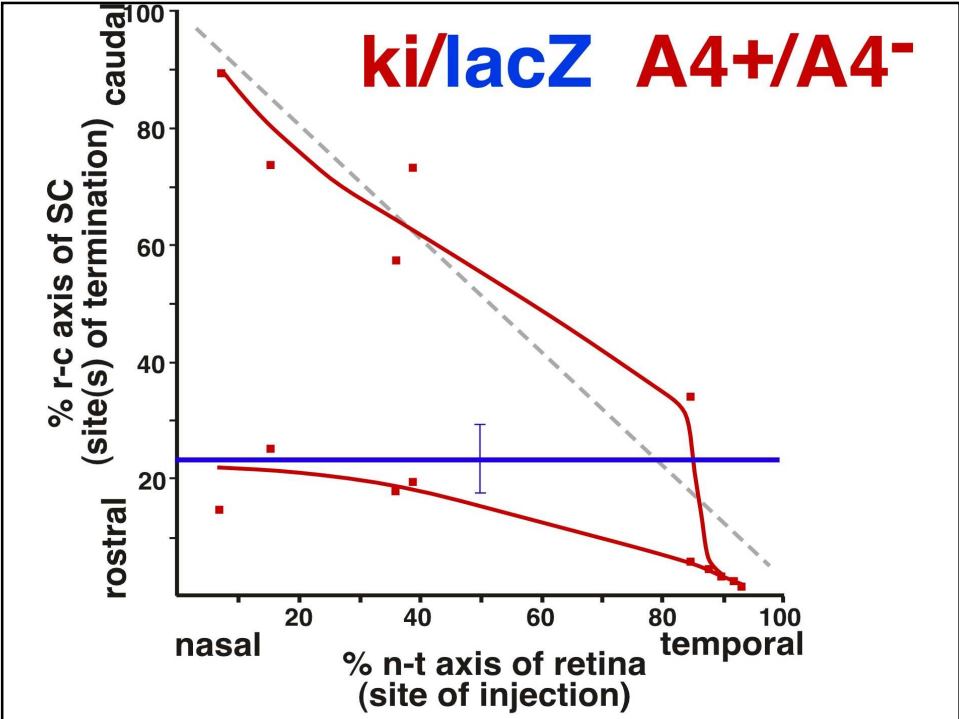
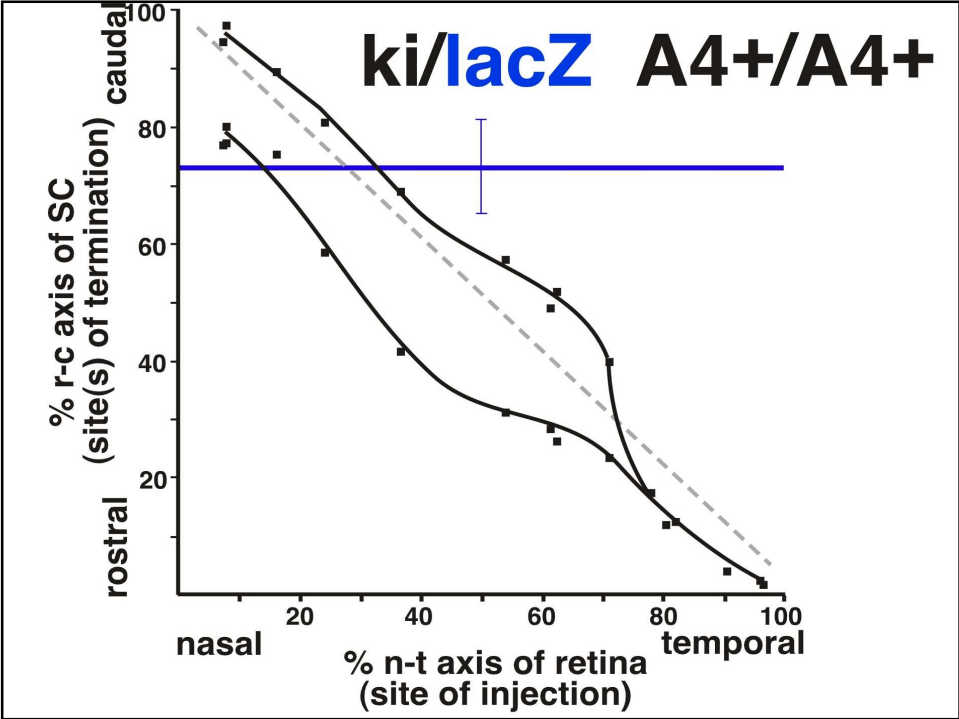

Topographic Wiring of the Eye to the Brain

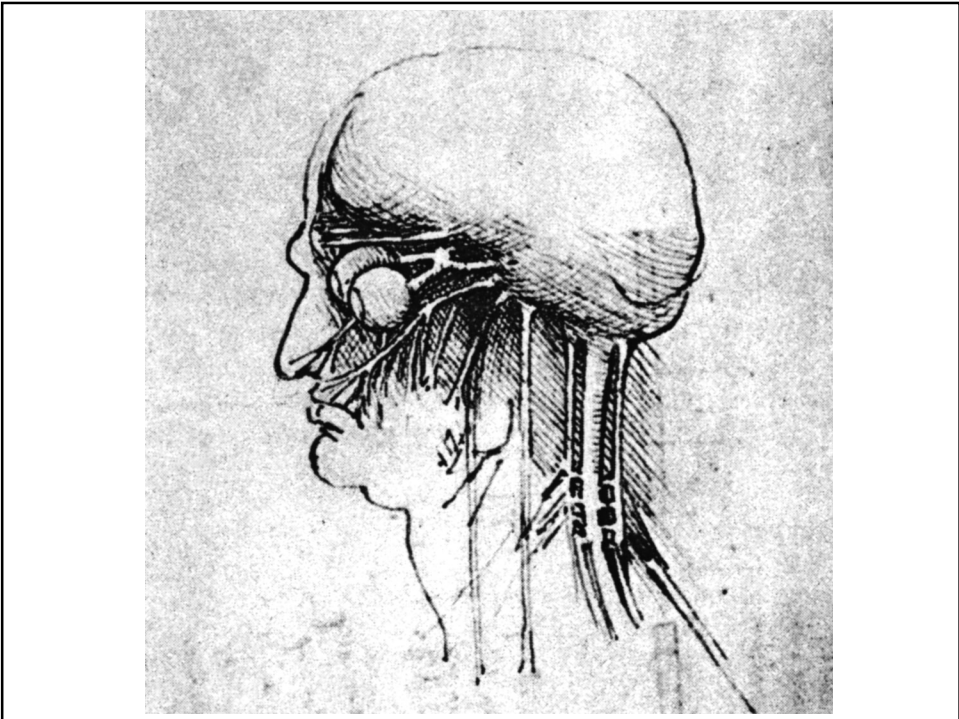
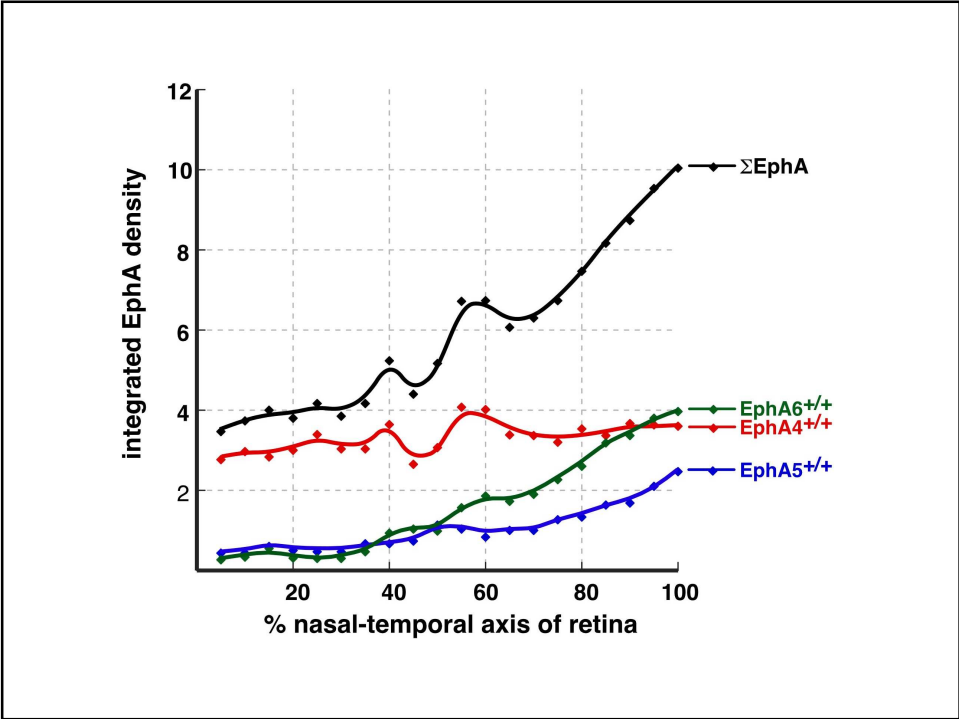

Colleagues

Arthur Brown	Ashish Vaidya
Paul Yates	Tom Jessell
Patrick Burrola	Sam Pfaff
Dan Ortuño	Dennis O'Leary
Darcie Baynes	Todd Garvey
Michaël Reber	Joe Hash
Stefano Bertuzzi	Robert Hindges
Stina Mui	Jin Woo Kim