

A. de Saint-Exupéry (1943)

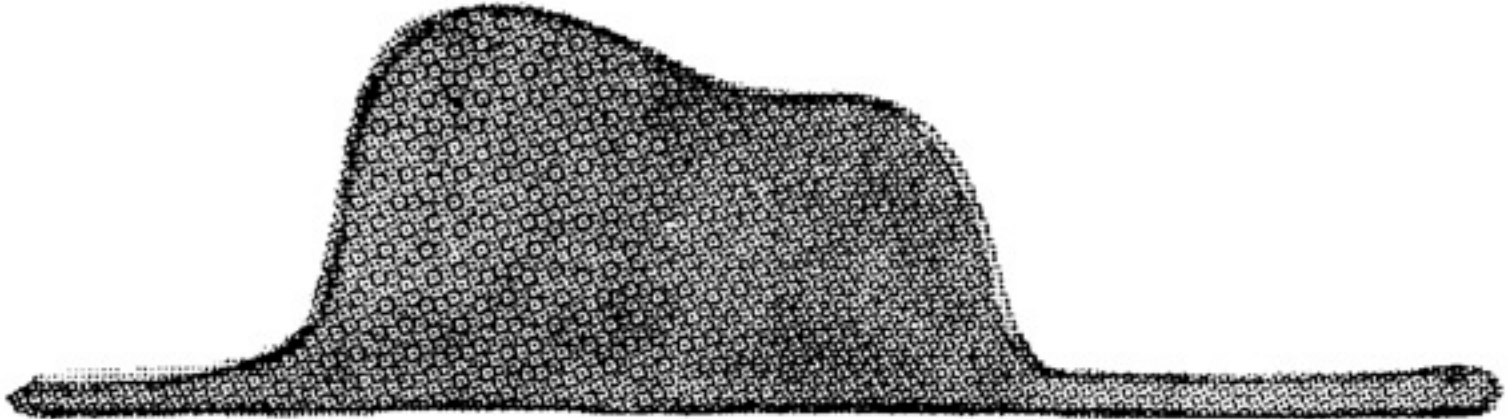

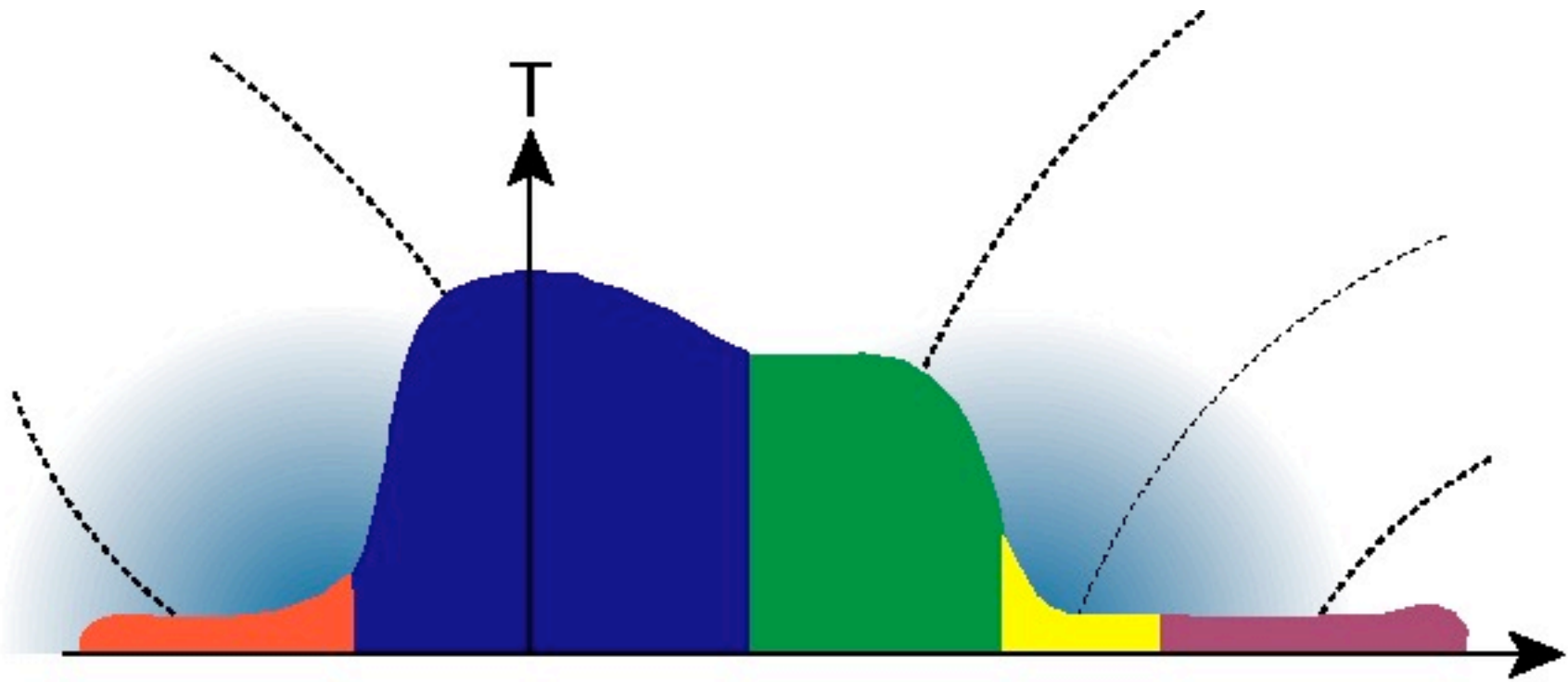

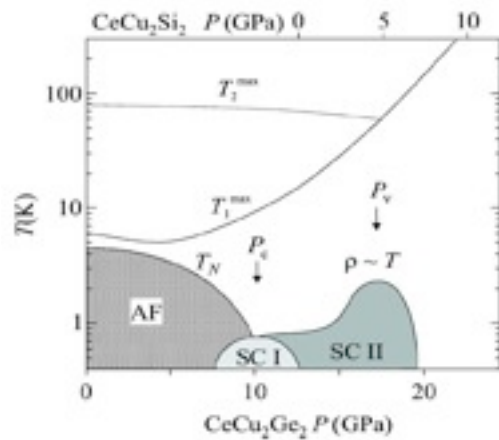
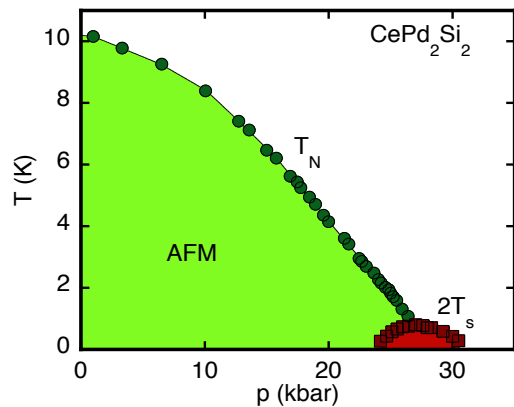
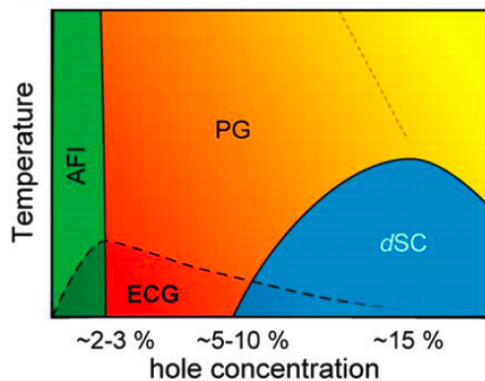
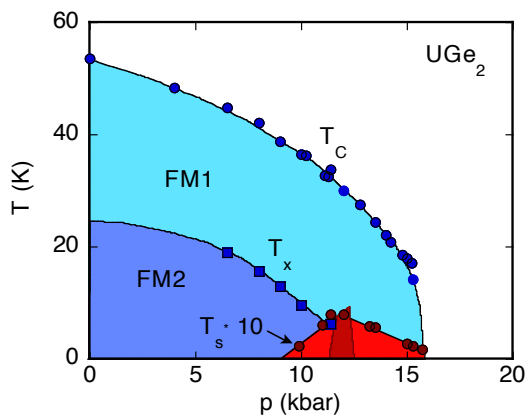
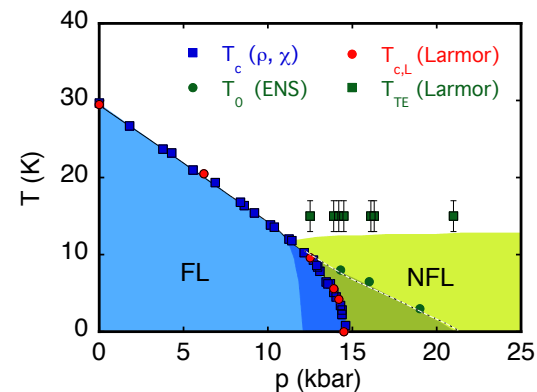
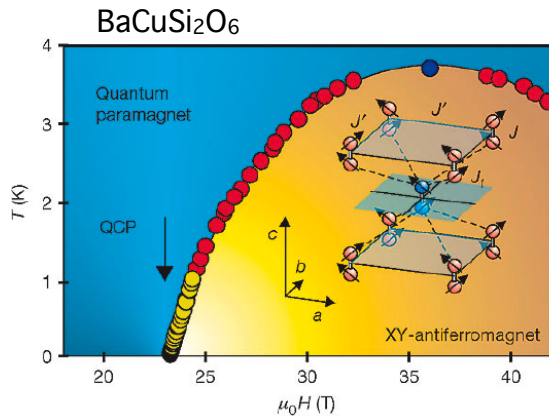
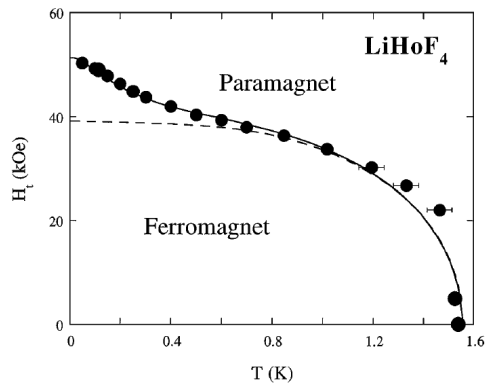

number of f-electron SC

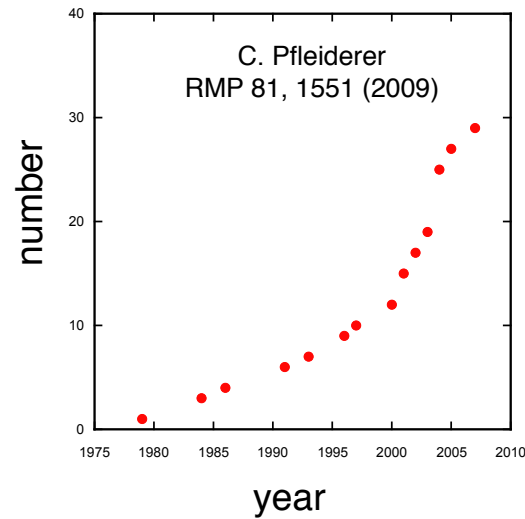

Why we find MnSi interesting...

Nature **442**, 797 (2006)

Science **323**, 915 (2009)

PRL **102**, 186602 (2009)

Science **330**, 1648 (2010)

Nature Physics **8** 301 (2012)

PRB **81**, 214436 (2010)

PRB **55**, 8330 (1997)

Nature Physics **3**, 29 (2007)

Science **316**, 1871 (2007)

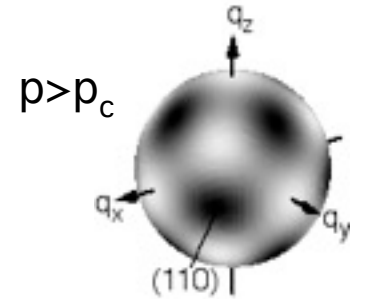
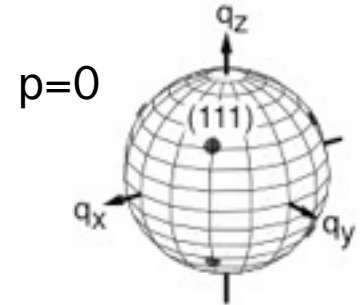
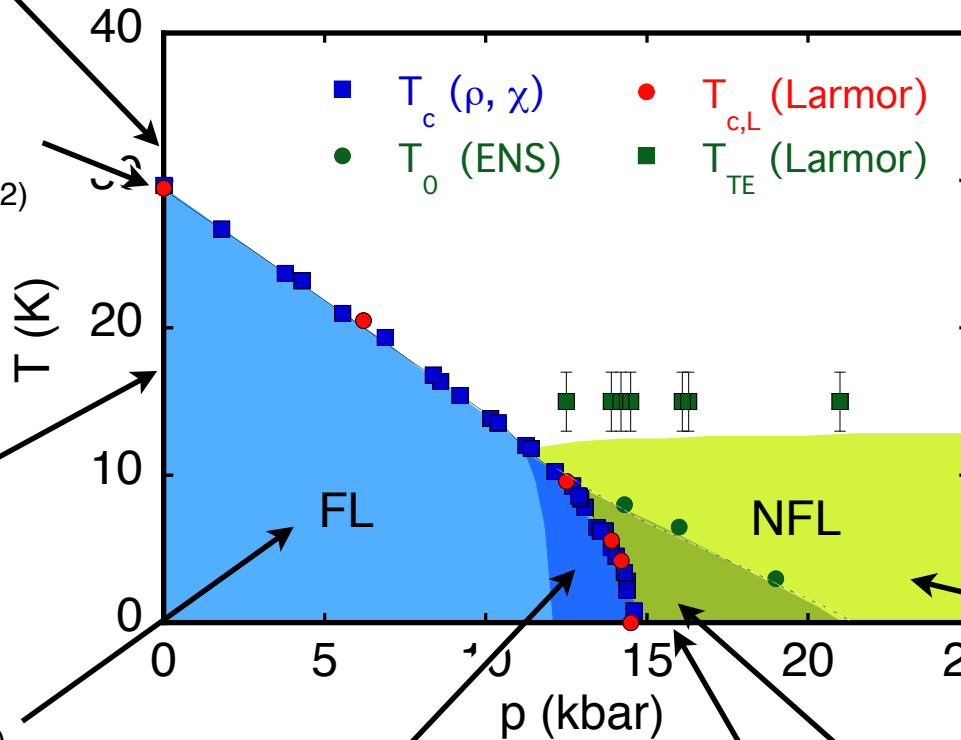

Nature **414**, 427 (2001)

Nature **427**, 227 (2004)

PRL **99**, 156406 (2007)

MnSi = Manganese Sil~~ic~~on

Manganese Sil~~ic~~ide

Manganese Suicide

Results Topic=(manganese suicide)

Timespan=All Years.

Search language=English Lemmatization=On

Scientific WebPlus^{NETA} View Web Results >>

Note: Alternative forms of your search term (for example, tooth and teeth) may have been applied, in particular for Topic or Title searches that do not contain quotation marks around the terms. To find only exact matches for your terms, turn off the "Lemmatization" option on the search page.

Results: 35

Page 1 of 1 Go

Sort by:

Publication Date -- newest to oldest

Refine Results

Search within results for

Search

► Databases

▼ Research Domains

Refine

SCIENCE TECHNOLOGY



(0)



Save to:

ENDNOTE WEB



Create Citation Report

ENDNOTE

ResearcherID

more options



1. Title: **STM study of growth of manganese suicide thin films on a Si(100)-2x1 surface**

Author(s): Li Wei-Cong; Zou Zhi-Qiang; Wang Dan; et al.

Source: ACTA PHYSICA SINICA Volume: 61 Issue: 6 Article Number:

066801 Published: MAR 2012

Times Cited: 0 (from All Databases)

Results Topic=(manganese suicide)

Timespan=All Years.

Search language=English Lemmatization=On

Results Topic=(manganese suicide)

Timespan=All Years.

Search language=English Lemmatization=On

Scientific WebPlus^{NETA} View Web Results >>

Note: Alternative forms of your search term (for example, tooth and teeth) may have been applied, in particular for Topic or Title searches that do not contain quotation marks around the terms. To find only exact matches for your terms, turn off the "Lemmatization" option on the search page.

Results: 35

Page 1 of 1 Go

Sort by:

Publication Date -- newest to oldest

Refine Results

Search within results for

Search

► Databases

▼ Research Domains

Refine

SCIENCE TECHNOLOGY

+ (0) | Save to: ENDNOTE[®] WEB

ENDNOTE[®] ResearcherID more options

Create Citation Report

1.

Title: **STM study of growth of manganese suicide thin films on a Si(100)-2x1 surface**

Author(s): Li Wei-Cong; Zou Zhi-Qiang; Wang Dan; et al.

Source: ACTA PHYSICA SINICA Volume: 61 Issue: 6 Article Number:

066801 Published: MAR 2012

Times Cited: 0 (from All Databases)

Title: **STM study of growth of manganese suicide thin films on Si(100)-2x1 surface**

STM study of growth of manganese silicide thin films on a Si(100)- 2×1 surface*

Li Wei-Cong¹⁾ Zou Zhi-Qiang^{1)2)†} Wang Dan¹⁾ Shi Gao-Ming¹⁾²⁾

Emergent Electrodynamics of Skyrmions in Chiral Magnets

Christian Pfleiderer



Physik-Department E21 - Technische Universität München



Collaborations

München

S. Mühlbauer
F. Jonietz
T. Adams
A. Bauer
A. Neubauer
W. Münzer
S. Gottlieb
P. Niklowitz³
M. Janoschek²
F. Bernlochner
J. Kindervater
M. Tischendorf
G. Brandl
S. Dunsiger
R. Ritz
T. Schulz
M. Halder
C. Franz
M. Wagner
A. Chacon
M. Hirschberger¹
F. Birkelbach
R. Georgii
T. Keller (MPI)
W. Häußler
P. Link
B. Pedersen
P. Böni
R. Hackl (WMI)

Köln

K. Everschor
M. Garst
B. Binz
A. Rosch

Utrecht

R. Duine

Lausanne

H. Berger

Berkeley

J. Koralek
D. Maier
J. Orenstein
A. Vishwanath

Braunschweig

P. Lemmens

¹Princeton ²Los Alamos ³London



Challenges in Spintronics

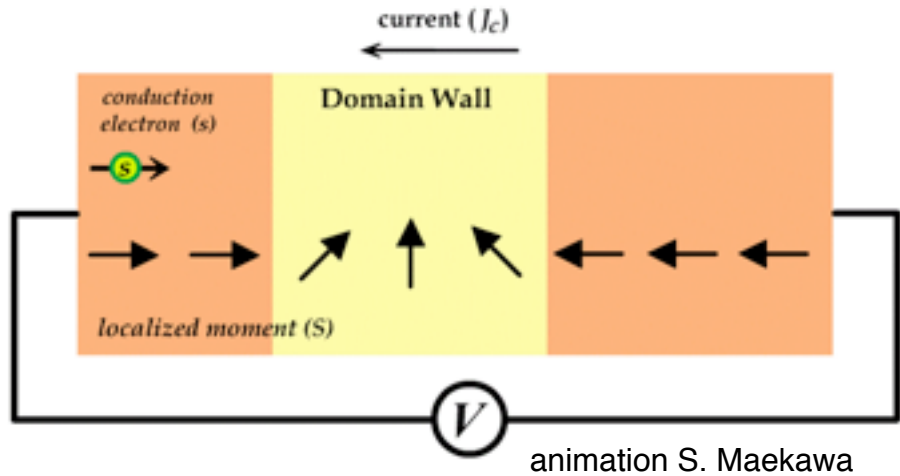

typical current density
 10^{12} A/m²

example for a Landau-Lifshitz Gilbert equation

$$\underbrace{(\partial_t + \vec{v}_s \nabla)}_{\text{Berry-phase spin torque}} \hat{M} = - \underbrace{\hat{M} \times \vec{H}_{\text{eff}}}_{\text{precession in effective field}} + \underbrace{\hat{M} \times (\alpha \partial_t + \beta \vec{v}_s \nabla) \hat{M}}_{\text{damping}} + \dots$$

What about Spin Transfer Torques in Helimagnets?

A. Rosch, R. Duine et al. (November 2006)

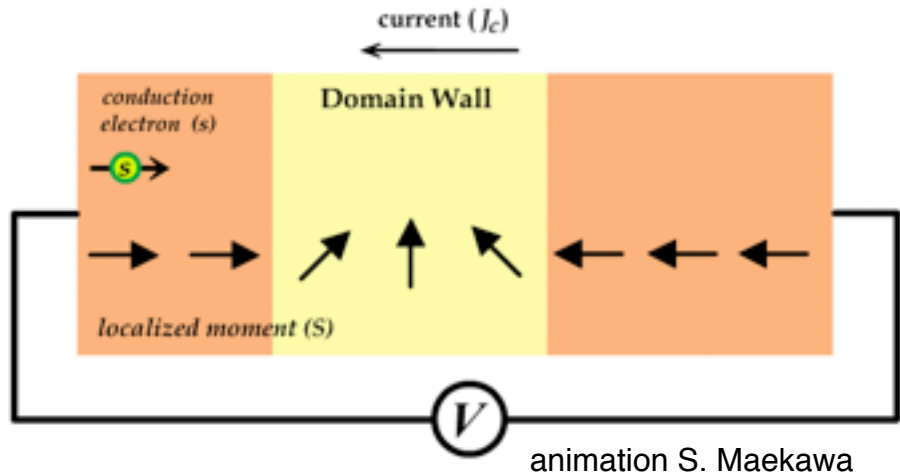

typical current density
 10^{12} A/m²

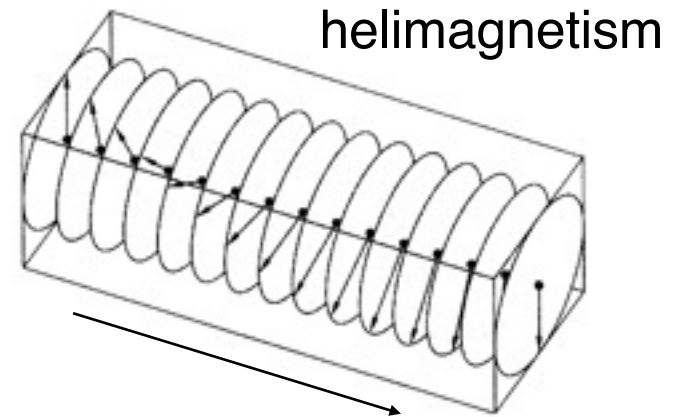
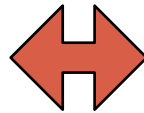
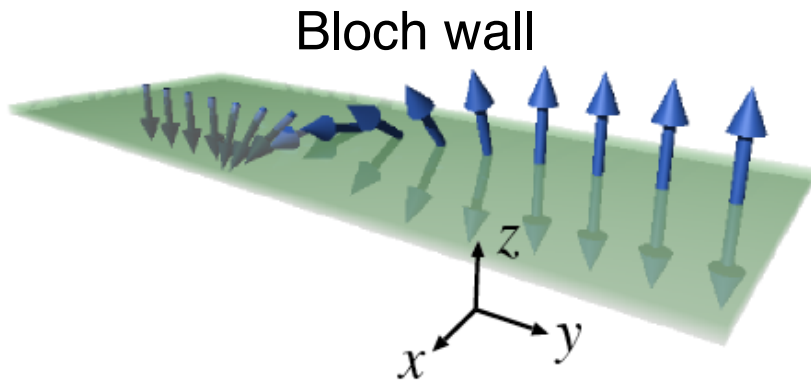

What about Spin Transfer Torques in Helimagnets?

A. Rosch, R. Duine et al. (November 2006)

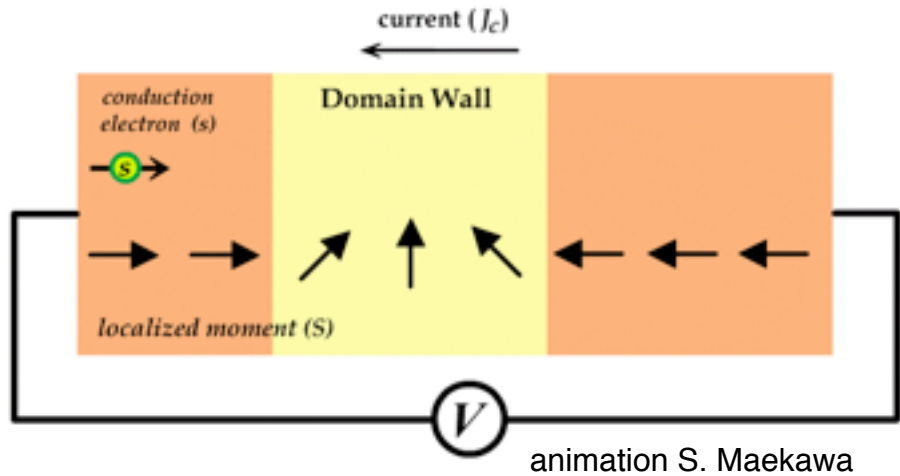

typical current density
 10^{12} A/m²

emergent electrodynamics:

$$\mathbf{B}_i^e = \frac{\hbar}{2} \epsilon_{ijk} \hat{n} \cdot (\partial_j \hat{n} \times \partial_k \hat{n})$$

$$\mathbf{E}_i^e = \hbar \hat{n} \cdot (\partial_i \hat{n} \times \partial_t \hat{n})$$

current density: 10^6 A/m² !!!

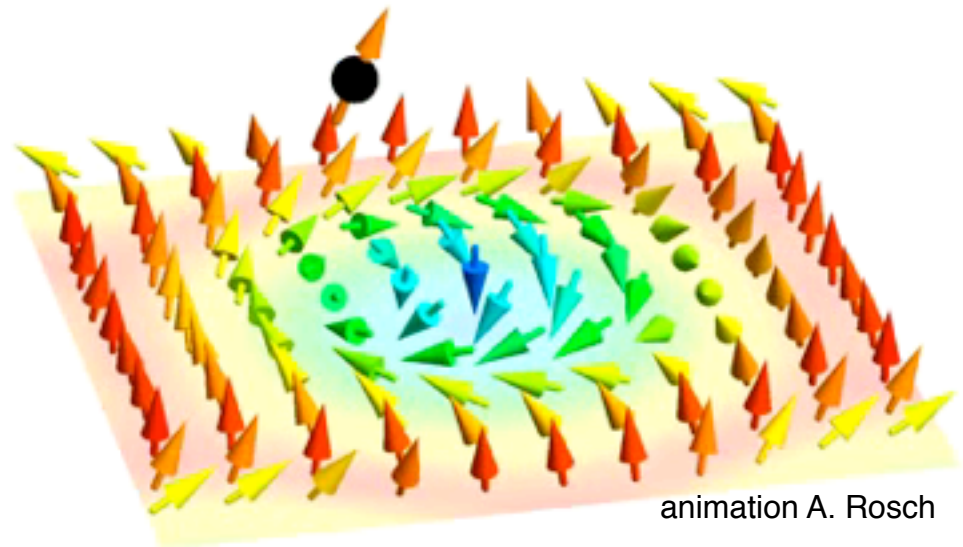

Outline

- A Very Short Introduction to B20 Compounds
- Exploring Spin Torques with Neutrons
- Rôle of Emergent Magnetic Field
- Emergent Electric Field
- Perspectives & Summary

A Very Short Introduction to B20 Compounds

Hierarchical Energy Scales in B20 compounds

Landau-Lifshitz vol. 8, §52

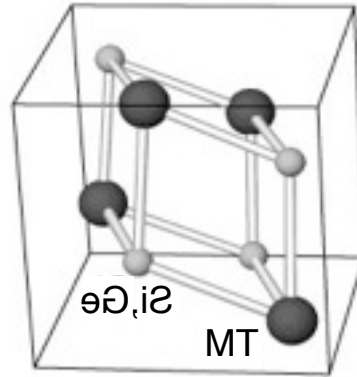
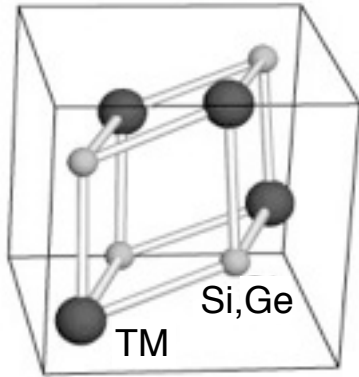

B20: no inversion center

B20: no inversion center



left-handed



right-handed

- (1) ferromagnetism
- (2) Dzyaloshinsky-Moriya
- (3) crystal field ($P2_13$):
locked to $\langle 111 \rangle$ or $\langle 100 \rangle$

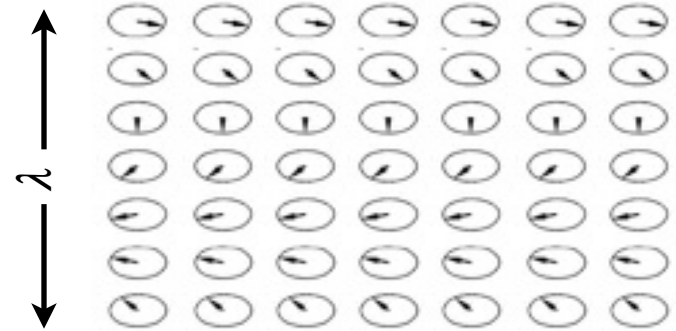

| | T_N (K) | λ (Å) |
|------------------|-----------|---------------|
| MnGe | 170 | 30 to 60 |
| $Mn_{1-x}Fe_xSi$ | < 28 | 180 to 120 |
| $Fe_{1-x}Co_xSi$ | < 45 | > 300 |
| FeGe | 280 | 700 |
| Cu_2OSeO_3 | 54 | 620 |

Fluctuation-Induced First Order Transition a helimagnetic Brazovskii transition

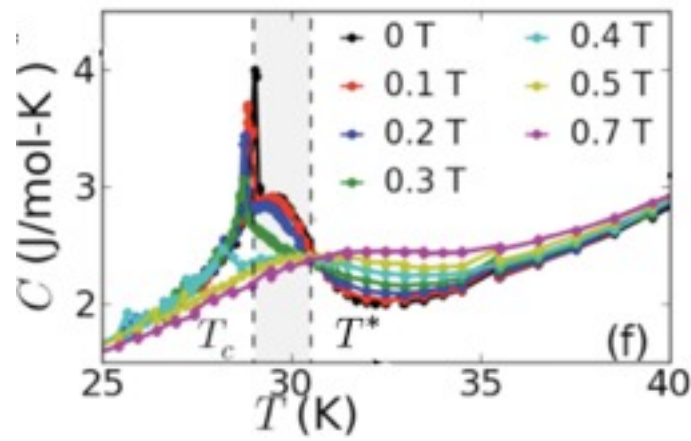
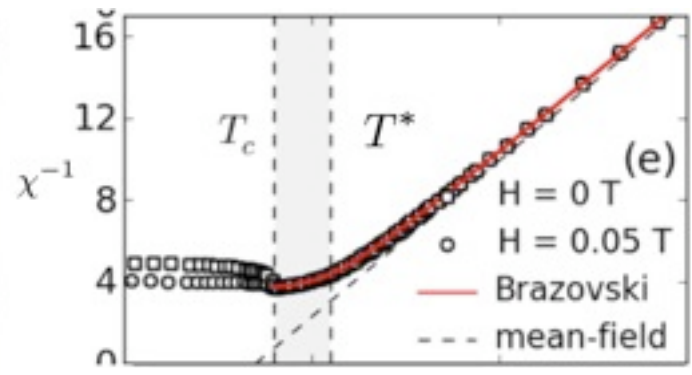
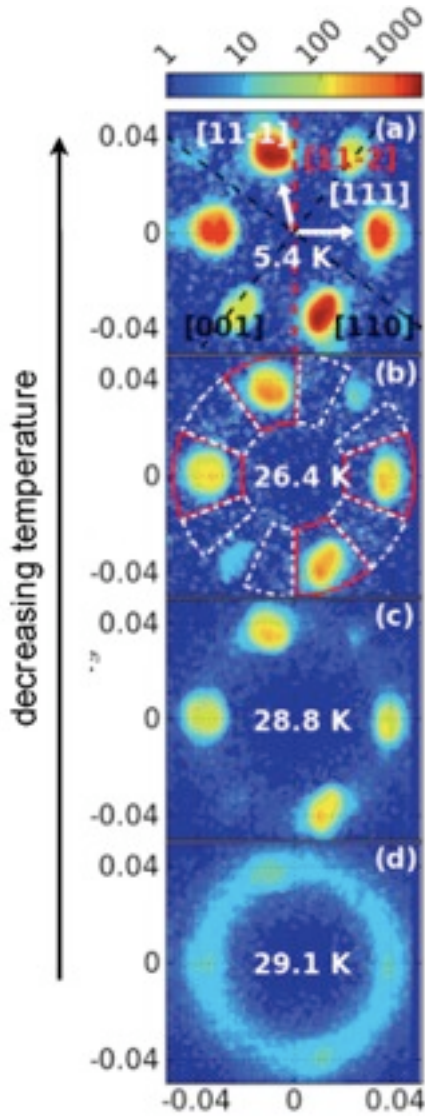

experiments @ MIRA, FRM II

M. Janoschek, M. Garst et al.
arXiv/1205.4780

FM exchange
 $J a = 11 \text{ meV}$

DM-interaction
 $D a^2 = J Q a^2 = 1.7 \text{ meV}$

cubic anisotropy
 $J_1 a = 0.37 \text{ meV}$

(a : lattice constant)

cf. claim of a Bak-Jensen
1st order transition

Helimagnon-Bands as Universal Excitations

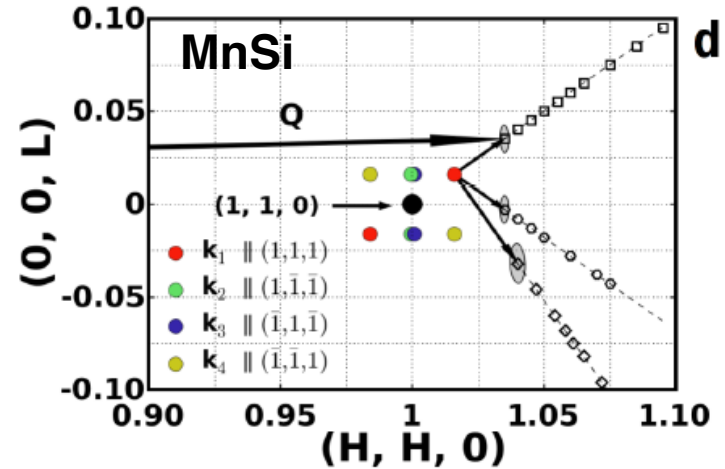
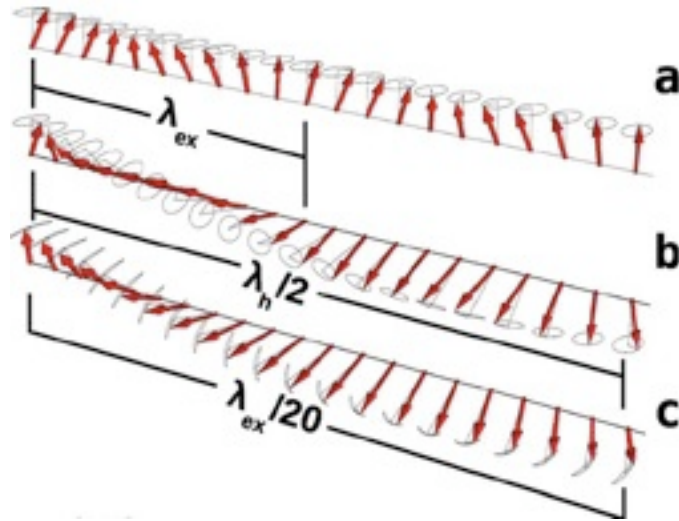

one parameter (intensity) simultaneously fits all data

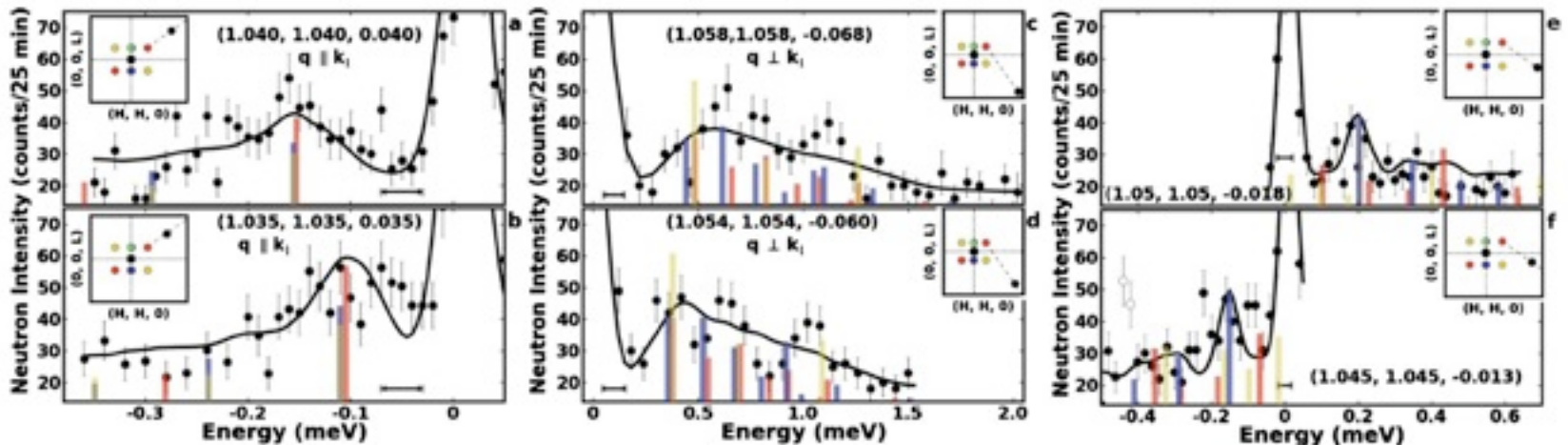

Janoschek, Bernlochner, Dunsiger, CP, Böni, Roessli, Link, Rosch, PRB **81**, 214436 (2010)

cf. pump-probe measurements in $\text{Fe}_{1-x}\text{Co}_x\text{Si}$: Koralek et al., arXiv/1208.1462

Magnetic Phase Diagram of MnSi

and similar B20 TM compounds

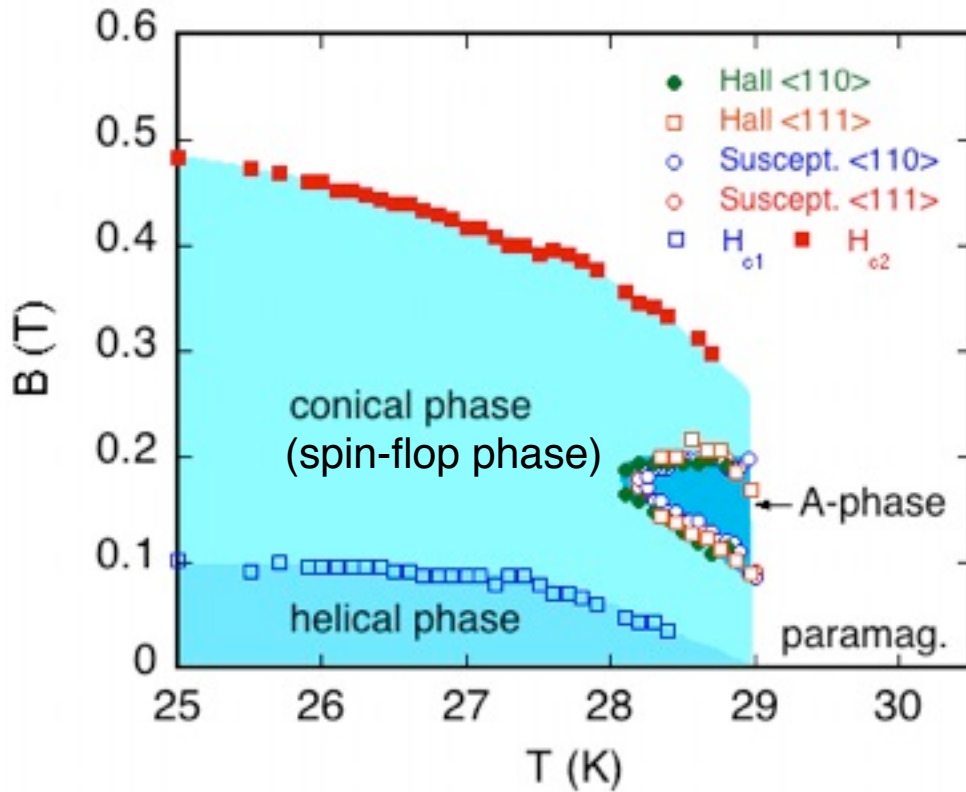

conical phase

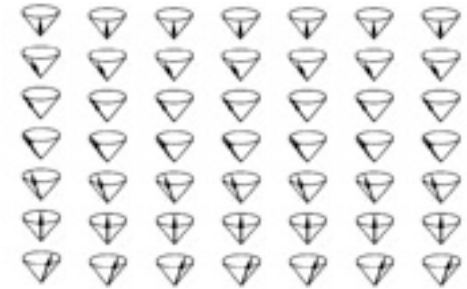

A phase



helical phase

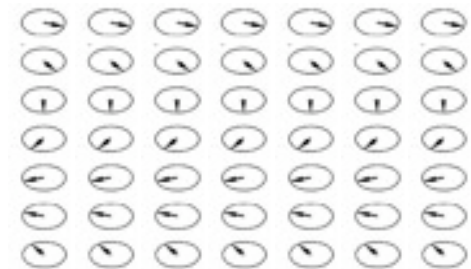

Neutron Scattering Pattern in the A-Phase

previous work

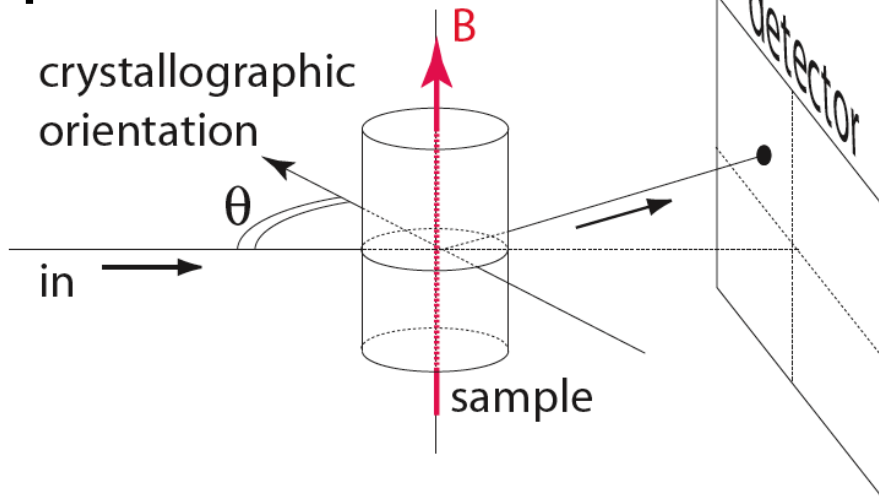

new work

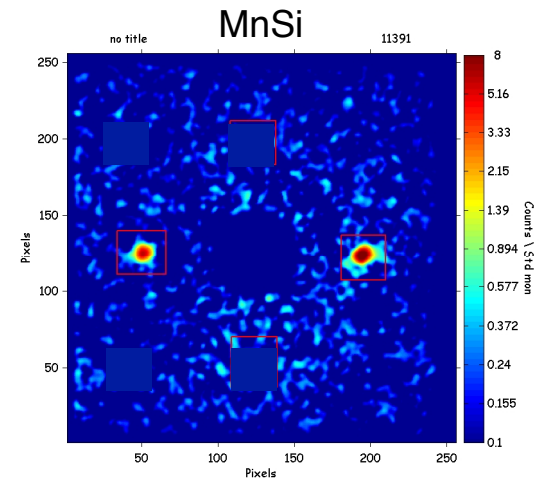
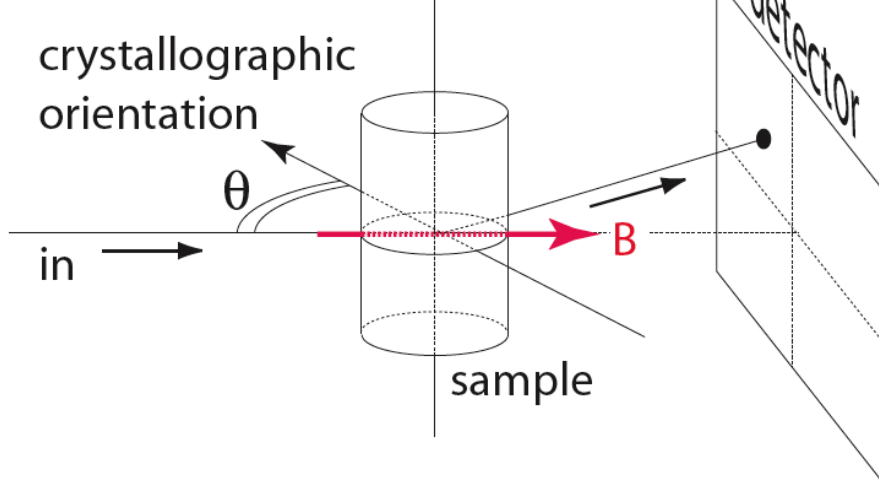

cf. Lebech, Bernhoeft (1993)
Grigoriev, et al. (2006)

angular variation

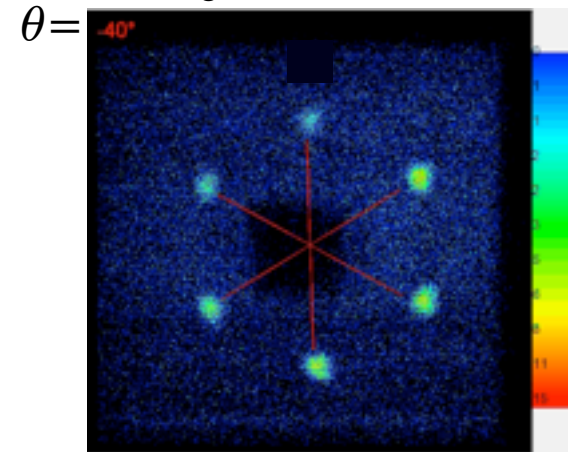

measurements @ MIRA, FRM II

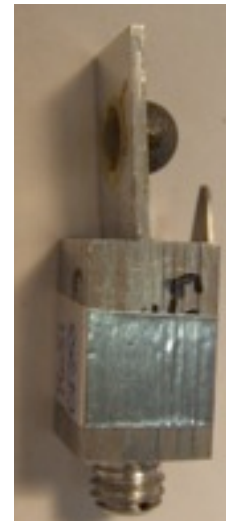

Fluctuation-Stabilized Multi-q Structure

$$F[\mathbf{M}] = \langle r_0 \mathbf{M}^2 + J(\nabla \mathbf{M})^2 + 2D \mathbf{M} \cdot (\nabla \times \mathbf{M}) + U \mathbf{M}^4 \rangle$$

$$\propto \langle \mathbf{M}_Q^2 \mathbf{M}_Q \rangle \cdot \mathbf{m}_0$$

triple-q + uniform m

Binz, Vishwanath, Aji PRL (2006)

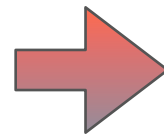
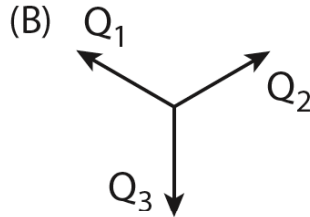
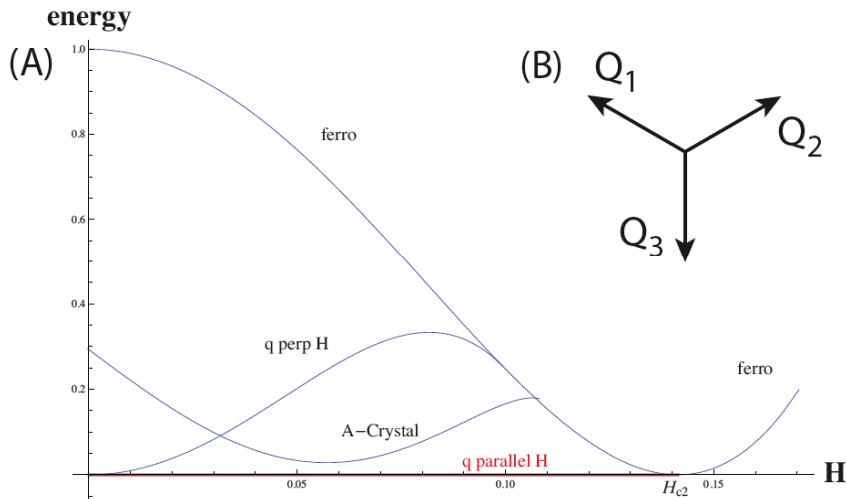

perp. single-q: **metastable**
triple-q: **metastable**

thermal Gaussian fluctuations

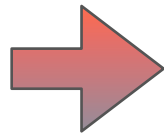

$$F \approx F_0 + \text{tr} \log \frac{\partial^2 F}{\partial \Phi \partial \Phi}$$

Mühlbauer et al, Science **323**, 915 (2009)

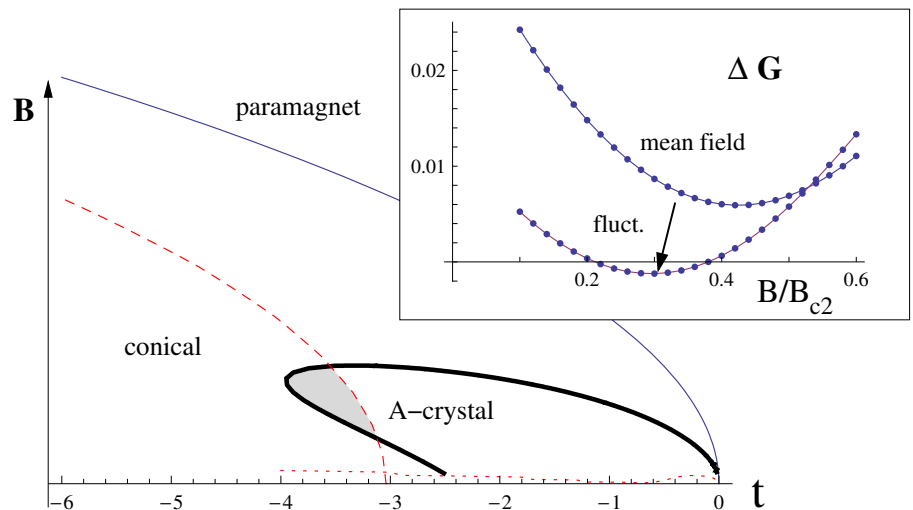

Topological Properties of the Rigorous Solution

phase btw fundamental modes

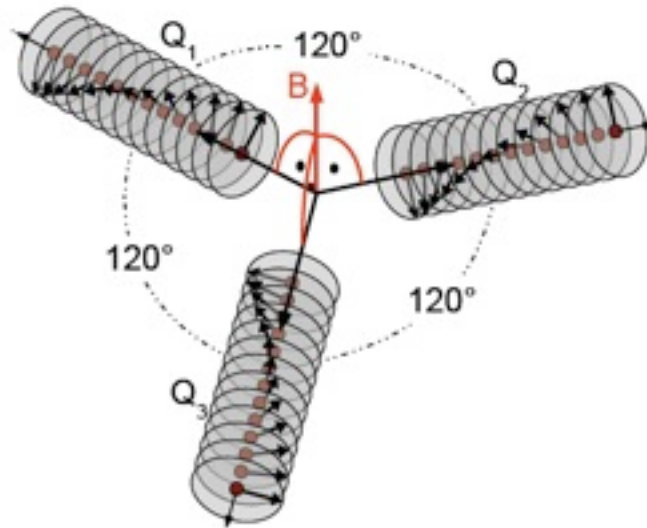

center: M antiparallel B

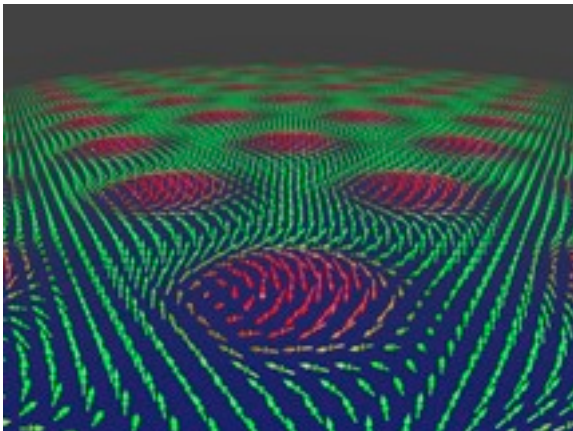

projection from above

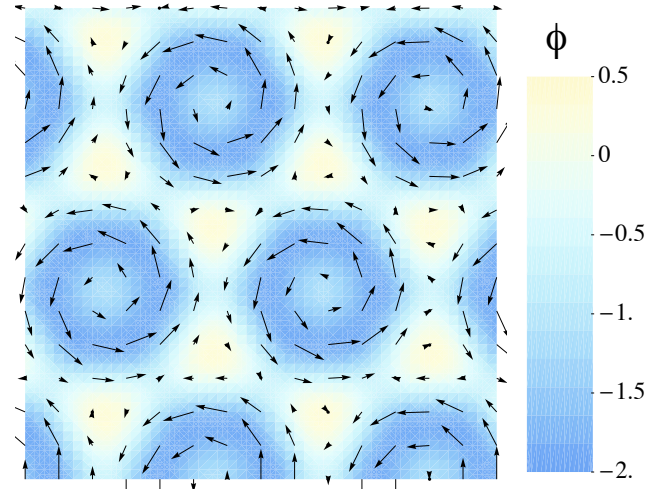

$$\phi = \frac{1}{4\pi} \vec{n} \cdot \frac{\partial \vec{n}}{\partial x} \times \frac{\partial \vec{n}}{\partial y}$$

winding number per unit cell:

$$\Phi = -1$$

lattice of topological knots



From „Hairy Balls“ to Skyrmion Lattices

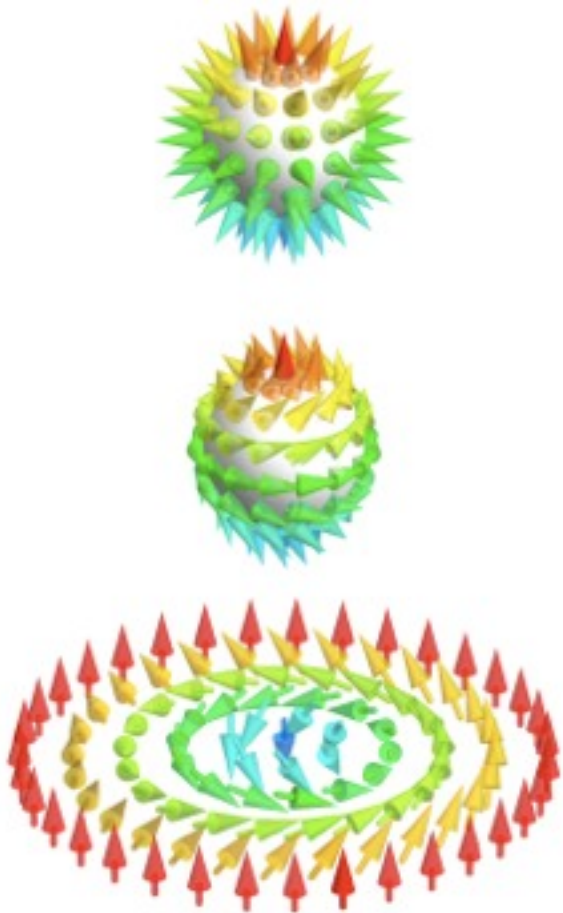

Werner Heisenberg

RMP **29** 296 (1957)



Tony Skyrme

Nucl. Phys. **31** 556 (1962)

Exploring Spin Torques with Neutrons

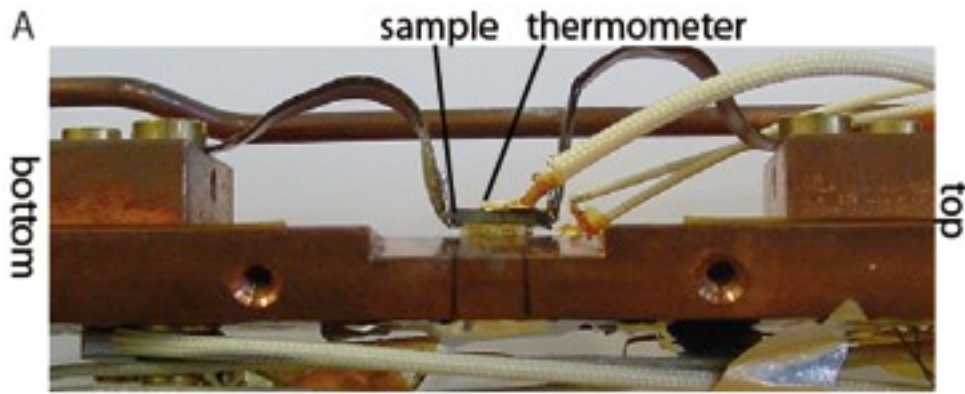

for neutron scattering
use special trick:

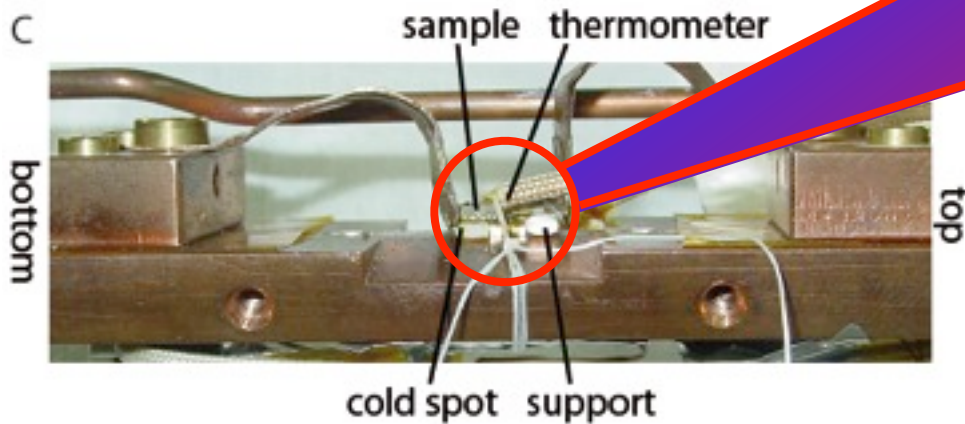
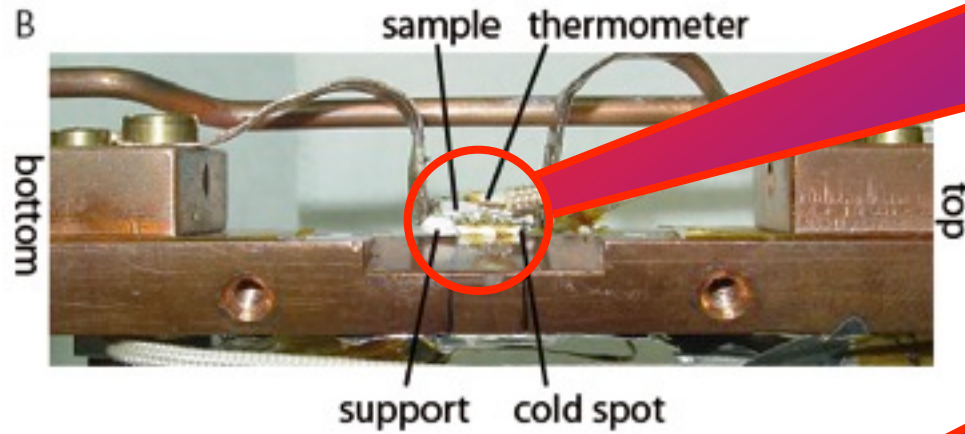

Experimental Setup

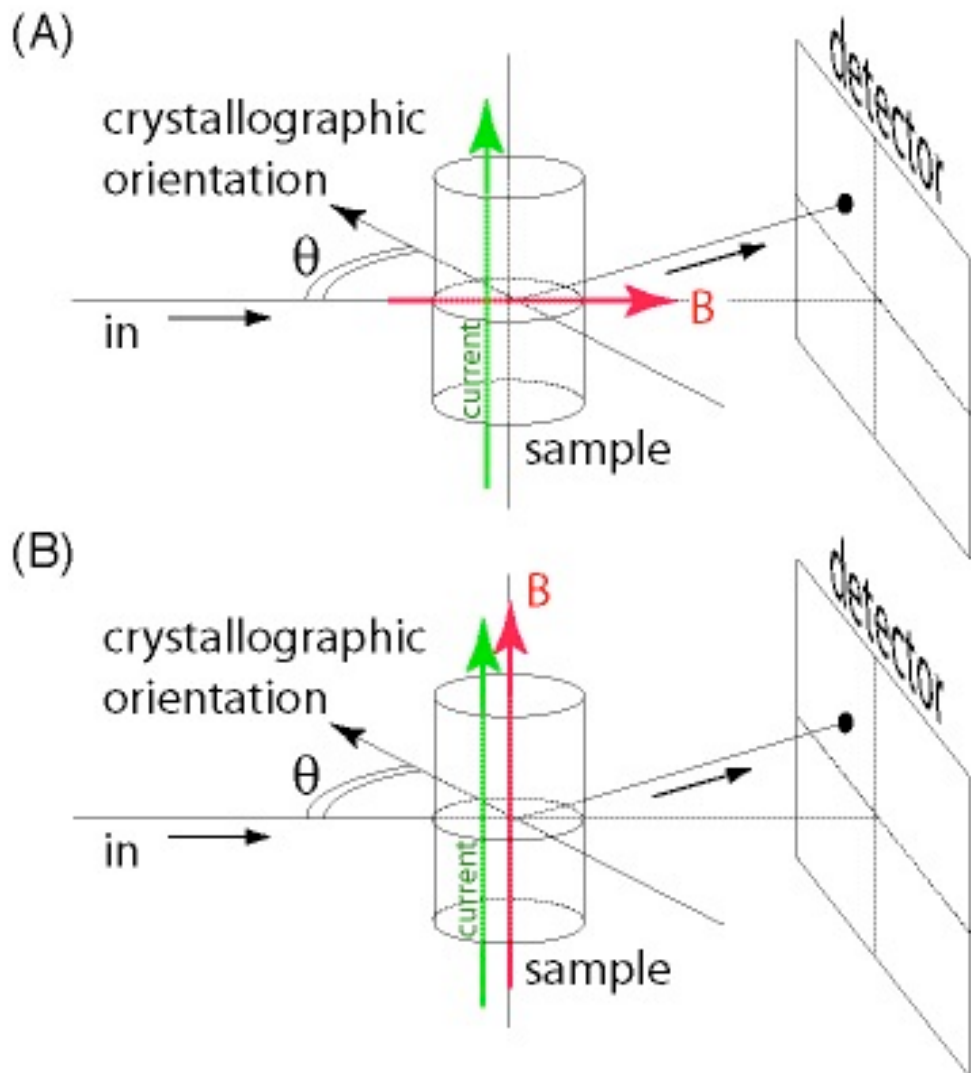

heat sink

thermometers

Al window

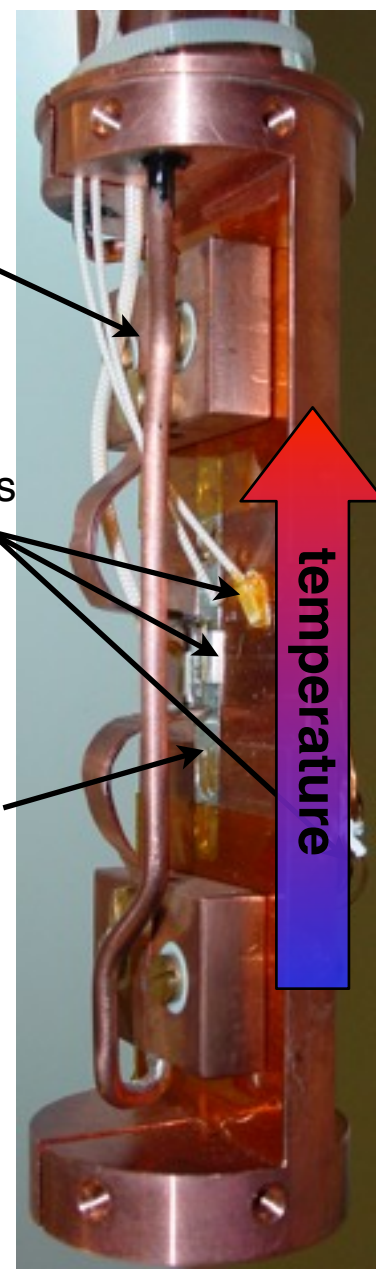

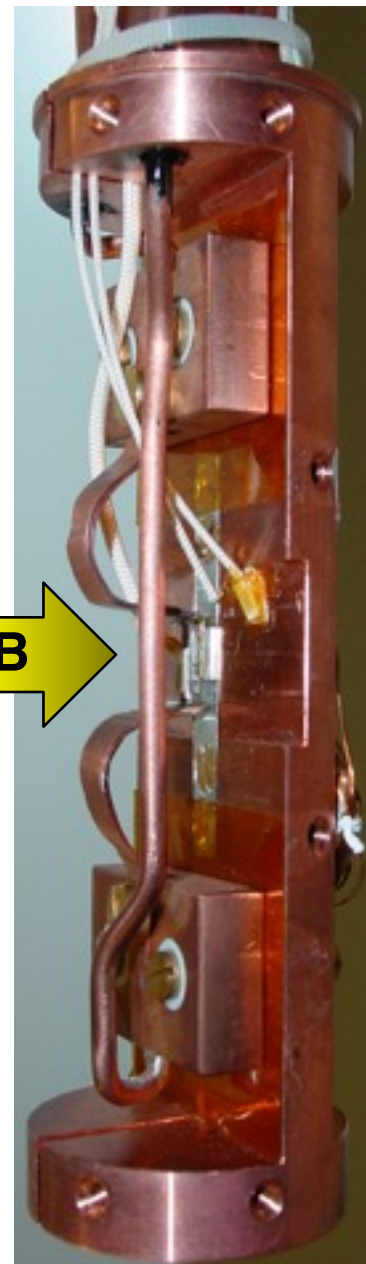
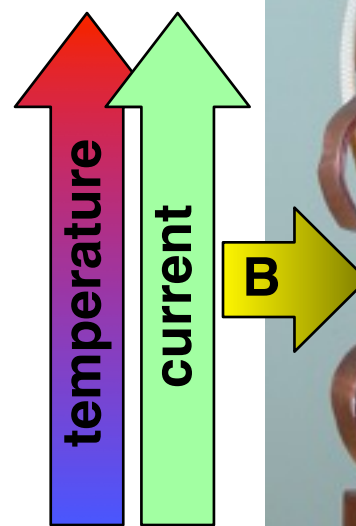
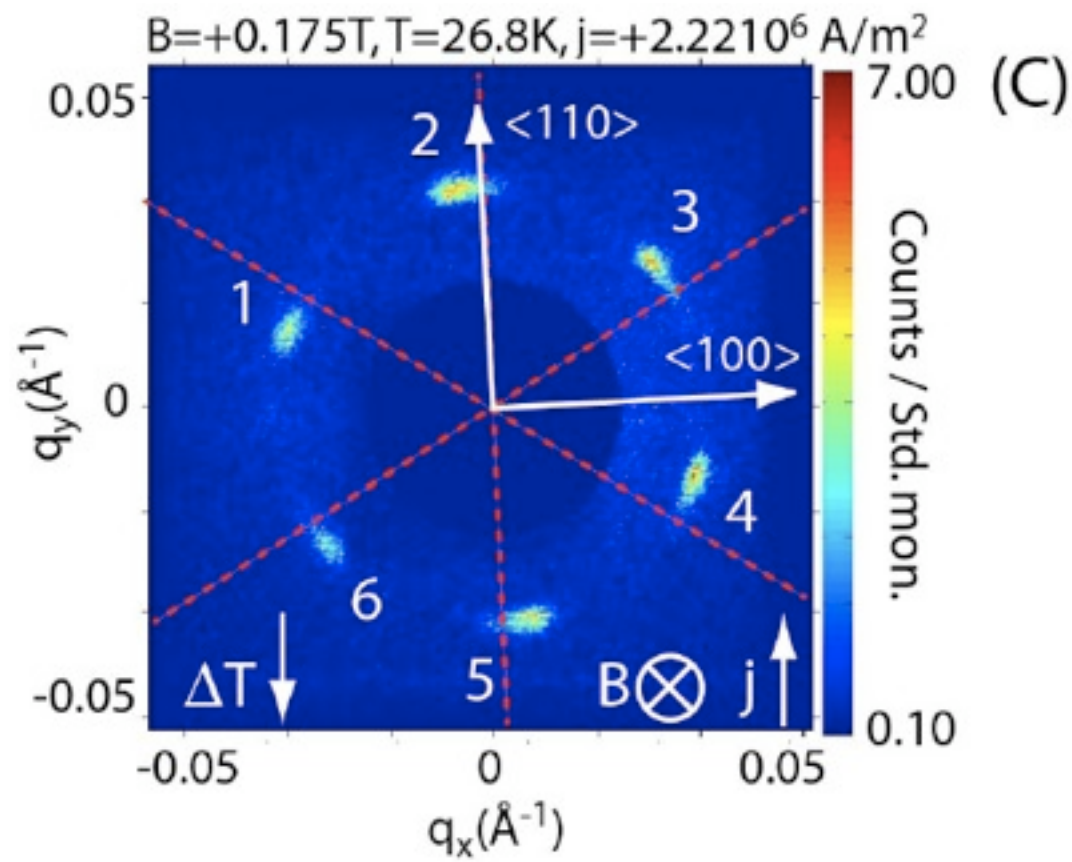

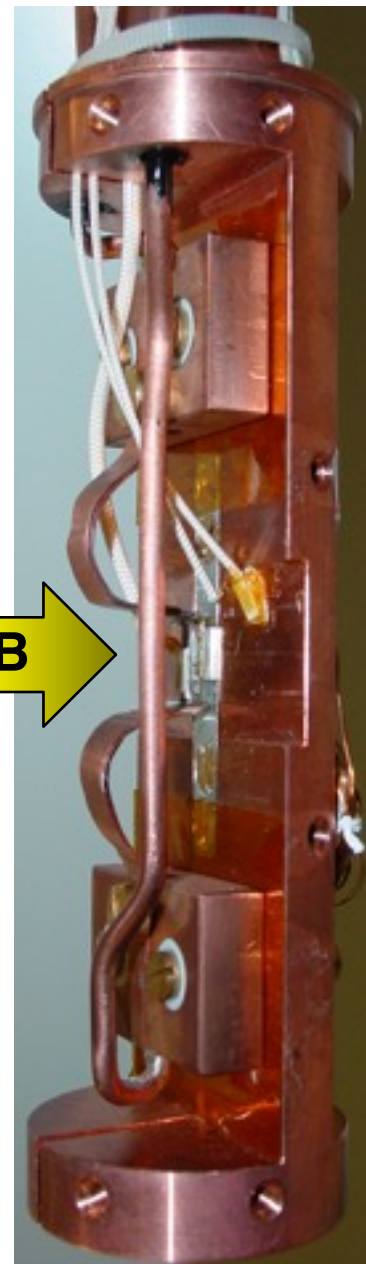
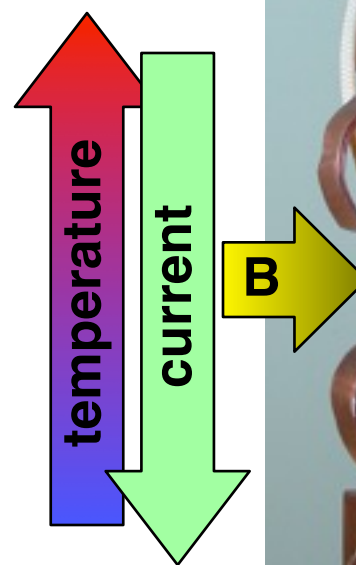
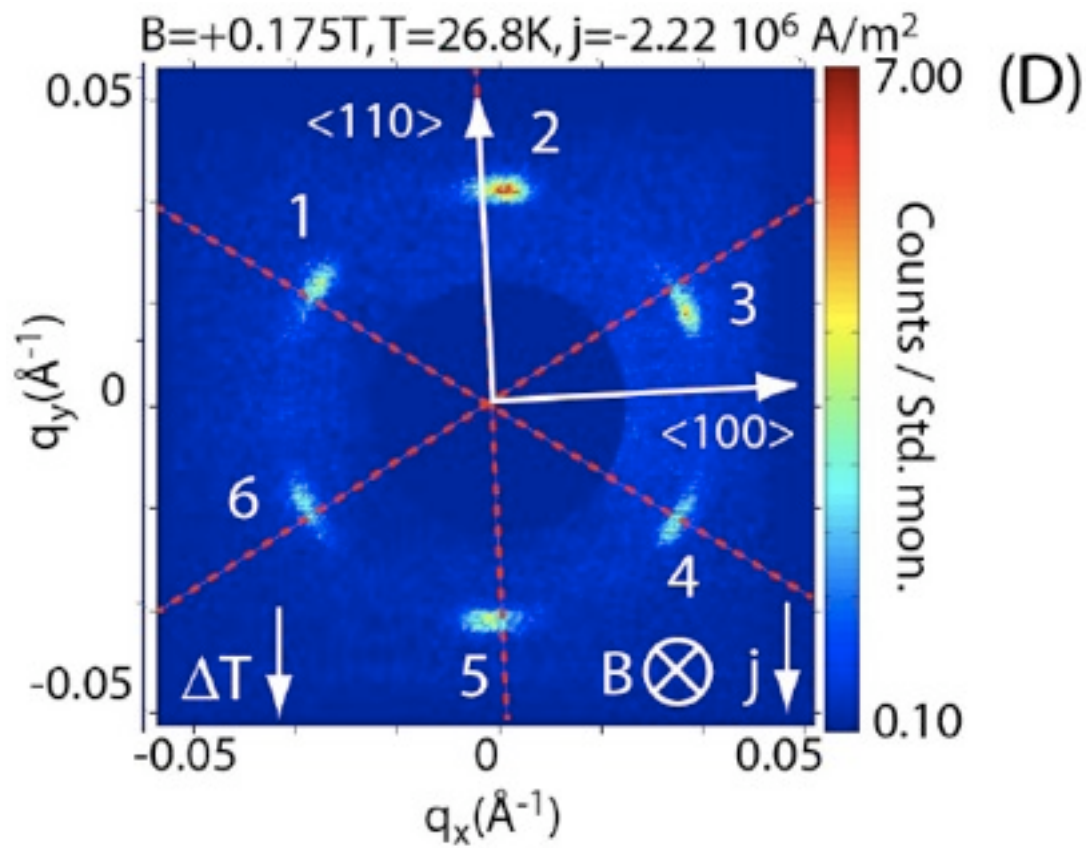

Current Dependence of the Rotation Angle

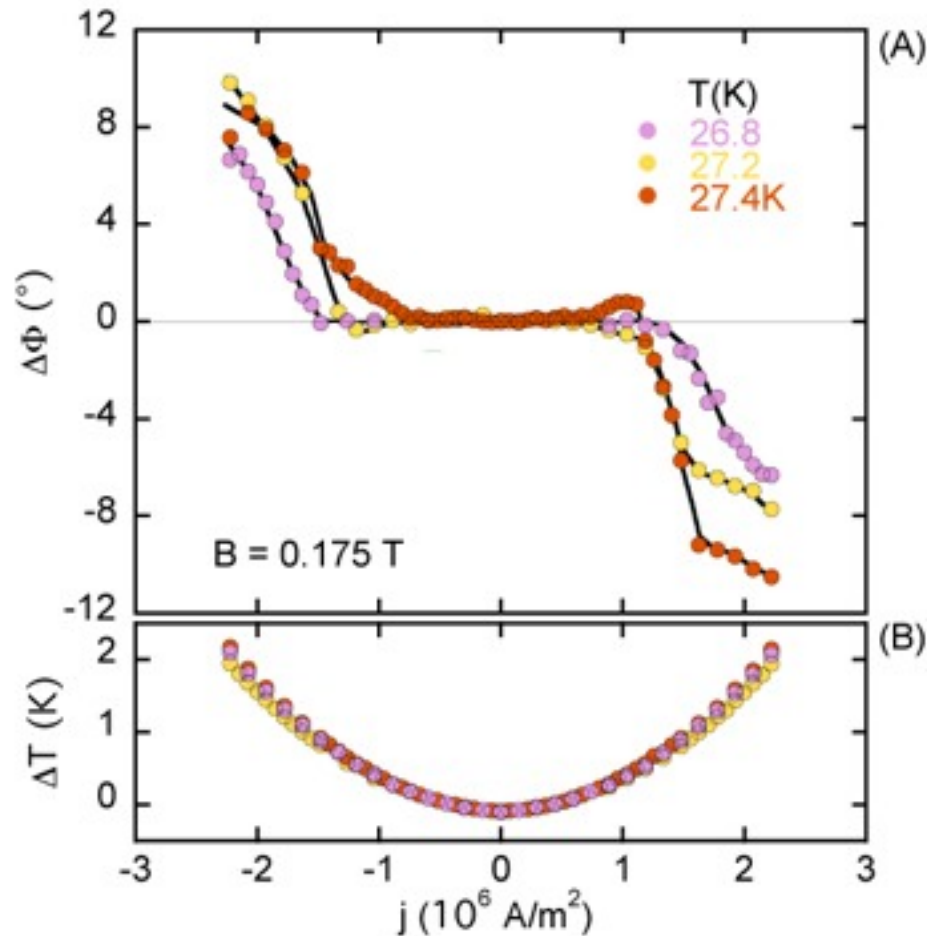

antisymmetric rotation
threshold: 10^6 Am $^{-2}$

temperature at surface
kept constant

Summary of Experimental Observations

- rotation for current perpendicular to field
- no effect for current parallel to applied field
- no effect in helical state
- no effect in conical state

sense of rotation changes under:

- inversion of current direction
 - inversion of field direction
 - inversion small T gradient
-
- low threshold for rotation: 10^6 Am^{-2}
 - same behavior for different sample shapes and orientations

Rôle of Emergent Magnetic Field

Emergent Magnetic Field of Skyrmions

Pfleiderer, Rosch Nature (N&V) 465 880 (2010)

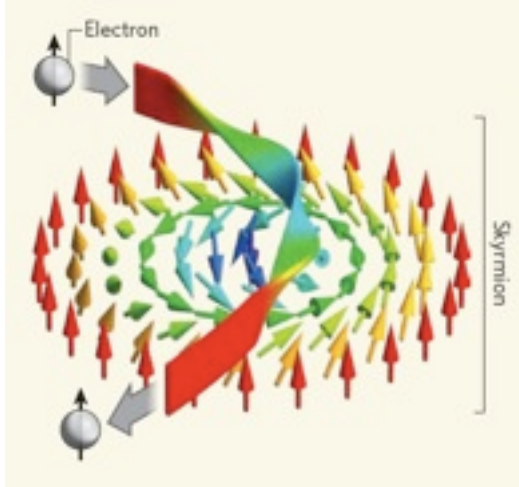

conduction electron tracks spin structure:

- ➔ collect Berry phase
- ➔ express as Aharonov-Bohm phase
- ➔ represents effective field

$$\vec{B}_{\text{eff}} = \Phi_0 \vec{\Phi}$$

$$\Phi_0 = h/e$$

$$\Phi^\mu = \frac{1}{8\pi} \epsilon_{\mu\nu\lambda} \hat{n} \cdot (\partial_\nu \hat{n} \times \partial_\lambda \hat{n})$$

trivial topology: $\Phi = 0$

non-trivial topology: $\Phi = -1$

➔ $\vec{B}_{\text{eff}} \approx -2.5 \text{ T}$

BUT: complex band structure!

$$\Delta\rho_{xy} \approx P R_0 B_{\text{eff}}^z \quad \text{➔} \quad \Delta\rho_{xy} \approx 4 \text{ n}\Omega \text{ cm}$$

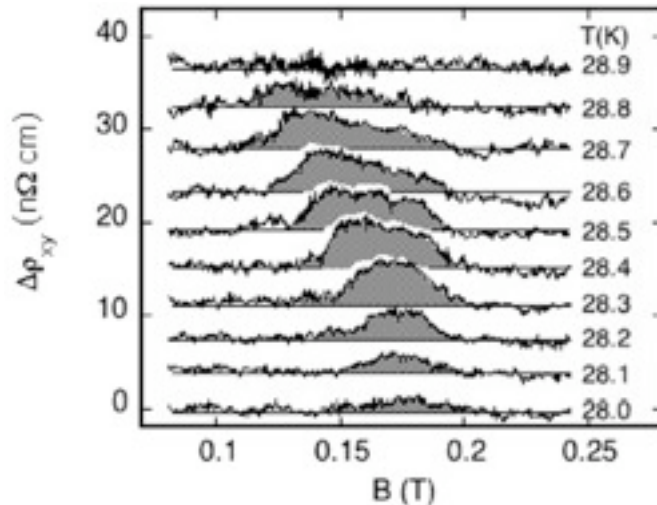

Binz, Vishwanath Physica B 403 1336 (2008)

Neubauer, et al. PRL 102 186602 (2009)

Rôle of the Temperature Gradient

Pfleiderer, Rosch Nature (N&V) 465 880 (2010)

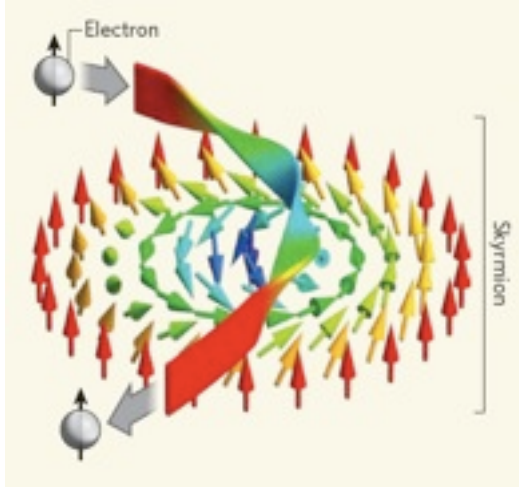

counter-force to „effective Lorentz force“

$$f_M \approx e j_s B_{\text{eff}} \quad p(T) = e j_s / j$$

$$\approx p(T) \cdot \frac{j}{10^6 \text{ A m}^{-2}} \frac{2.7 \cdot 10^{-10} k_B T_c}{a^4}$$

T gradient \Rightarrow gradient of spin current

$$\nabla p \approx \frac{\partial p}{\partial T} \nabla T$$

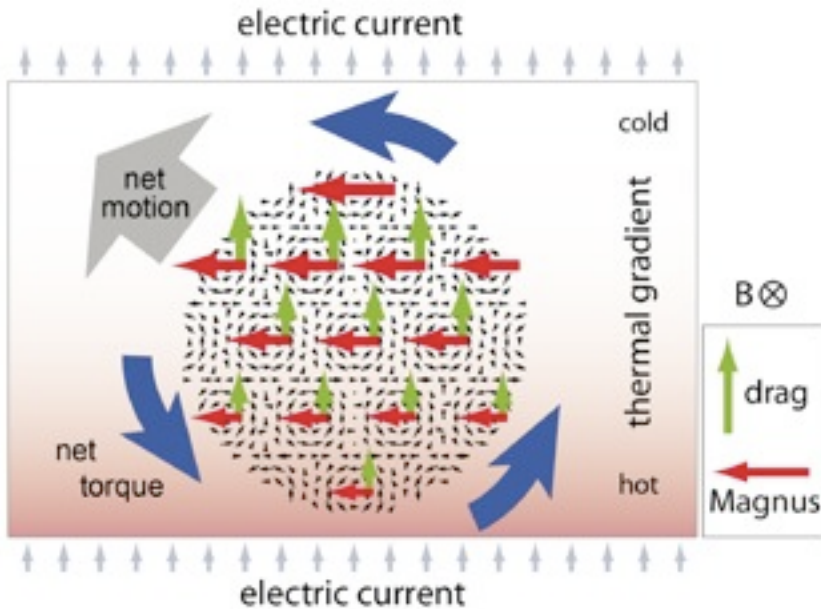

resulting torque on skyrmion lattice

$$\tau_M \sim \int \mathbf{r} \times \mathbf{f}_M(\mathbf{r}) d^3 r / V$$

$$\tau_M \sim 10^{-10} \frac{\mathbf{j} \cdot \nabla p}{10^6 \text{ A m}^{-2}} \frac{R^2 k_B T_c}{a a^3}$$

(assumes rigid skyrmion lattice)

Proposal of Rotating Skyrmion Lattices in Temperature or Field Gradients

restoring force:
higher-order
spin-orbit cplg.

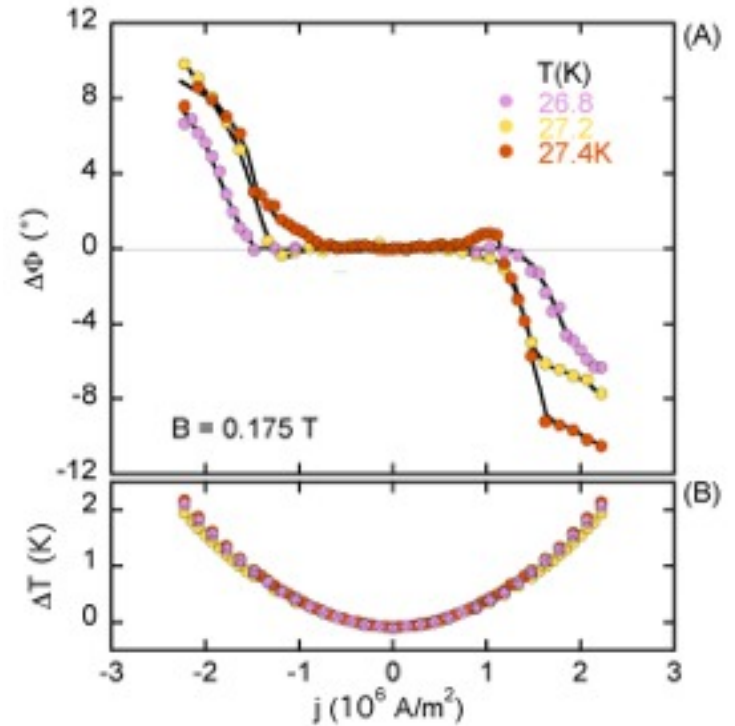
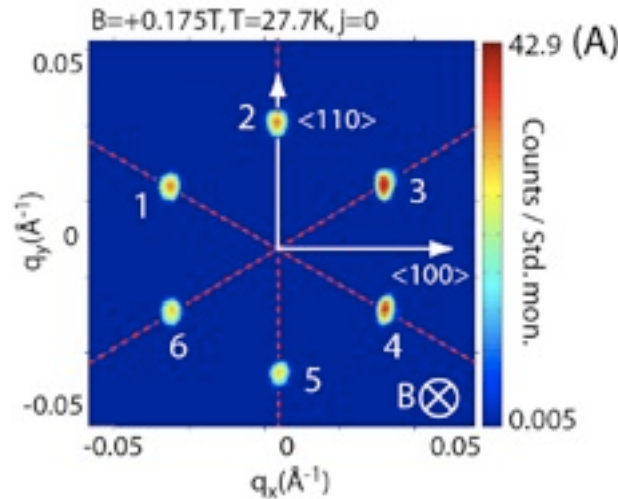

some domains
continuously rotate
(comet tails)

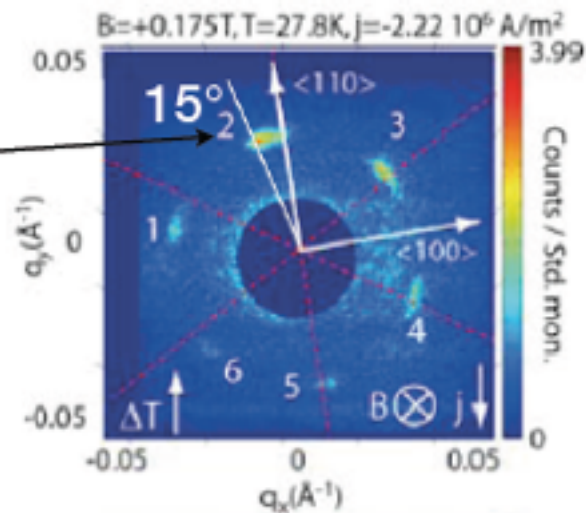

Everschor et al., PRB **86** 054432 (2012)

Why ultra-low current densities?

very efficient gyro-coupling via Berry phase
+ coupling over entire magnetic domains

very weak pinning forces

+ low defect concentration ($RRR > 100$)

+ very smooth magnetic texture (200\AA)

+ very stiff magnetic order

cf. collective pinning in superconductors

consider Landau-Lifshitz-Gilbert equation

$$\underbrace{(\partial_t + \vec{v}_s \nabla) \hat{M}}_{\text{Berry-phase spin torque}} = \underbrace{-\hat{M} \times \vec{H}_{\text{eff}}}_{\text{precession in effective field}} + \underbrace{\hat{M} \times (\alpha \partial_t + \beta \vec{v}_s \nabla) \hat{M}}_{\text{damping}} + \dots$$

cf Zhang & Lee PRL (2004)
add'l damping, cf Zang et al PRL (2010)

two types spin currents:

(1) difference of spin polarisation of charge currents

$$j_s = j_{\uparrow} - j_{\downarrow}$$

(2) gradients in spin orientation:
here super-spin current

cf charge supercurrents
due to phase gradients

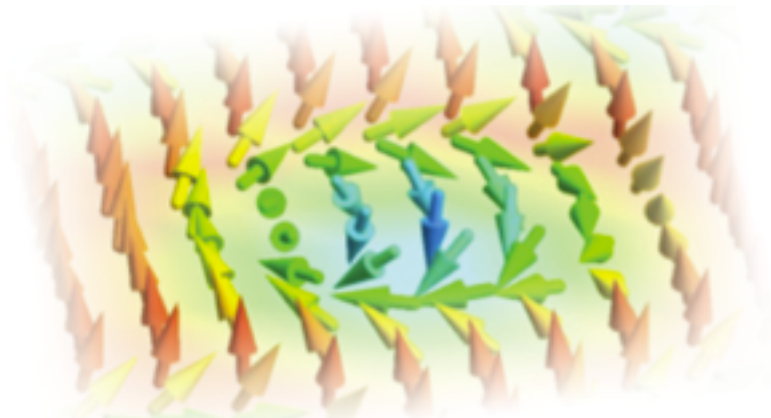

consider Landau-Lifshitz-Gilbert equation

$$\underbrace{(\partial_t + \vec{v}_s \nabla) \hat{M}}_{\text{Berry-phase spin torque}} = \underbrace{-\hat{M} \times \vec{H}_{\text{eff}}}_{\text{precession in effective field}} + \underbrace{\hat{M} \times (\alpha \partial_t + \beta \vec{v}_s \nabla) \hat{M}}_{\text{damping}} + \dots$$

cf Zhang & Lee PRL (2004)
add'l damping, cf Zang et al PRL (2010)

two types spin currents:

(1) difference of spin polarisation of charge currents

$$j_s = j_{\uparrow} - j_{\downarrow}$$

(2) gradients in spin orientation:
here super-spin current

cf charge supercurrents
due to phase gradients

„spin current Magnus force“

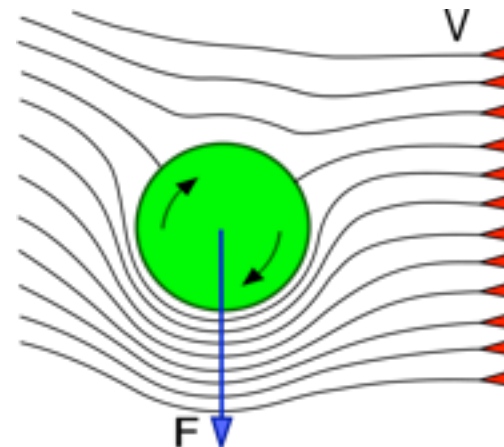

consider Landau-Lifshitz-Gilbert equation

generalized Thiele approach (project LLG on zero modes)

$$\vec{G} \times (\vec{v}_s - \dot{\vec{x}}(t)) + \mathcal{D}(\beta \vec{v}_s - \alpha \dot{\vec{x}}(t)) = \vec{F}_{\text{pinning}}$$

$$G_i = \frac{1}{2} \varepsilon_{ijk} \int d\mathbf{r} \hat{M} (\partial_j \hat{M} \times \partial_k \hat{M})$$

topological winding number

gyrocoupling vector

$$\mathcal{D}_{ij} = \int d\mathbf{r} \partial_i \hat{M} \partial_j \hat{M}$$

dissipative tensor

consider Landau-Lifshitz-Gilbert equation

generalized Thiele approach (project LLG on zero modes)

$$\vec{G} \times (\vec{v}_s - \dot{\vec{x}}(t)) + \mathcal{D}(\beta \vec{v}_s - \alpha \dot{\vec{x}}(t)) = \vec{F}_{\text{pinning}}$$

$$G_i = \frac{1}{2} \varepsilon_{ijk} \int d\mathbf{r} \hat{M} (\partial_j \hat{M} \times \partial_k \hat{M})$$

topological winding number

gyrocoupling vector

$$\mathcal{D}_{ij} = \int d\mathbf{r} \partial_i \hat{M} \partial_j \hat{M}$$

dissipative tensor

for $F_{\text{pin}} \approx 0$ drift and spin-Magnus force

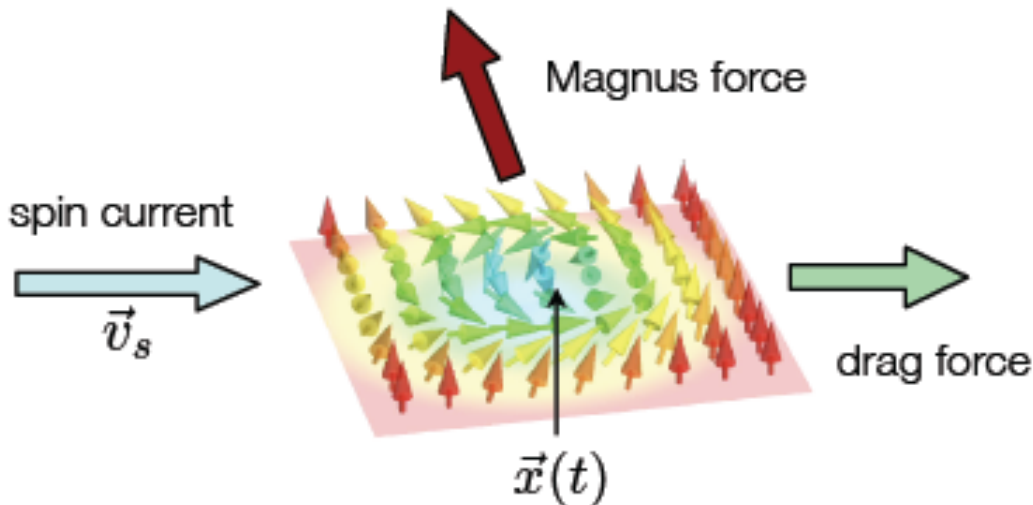

$$\vec{F}_{\text{Magnus}} \propto \vec{B} \times (\vec{v}_s - \vec{v}_d)$$

$$\vec{F}_{\text{Magnus}} + \vec{F}_{\text{fric}} = 0$$

no friction: $\vec{v}_d = \vec{v}_s$

with friction: $\vec{F}_{\text{fric}} \sim \gamma \vec{v}_d$

$$\vec{v}_d \approx \gamma^{-1} \vec{B} \times \vec{v}_s$$

Emergent Electric Field

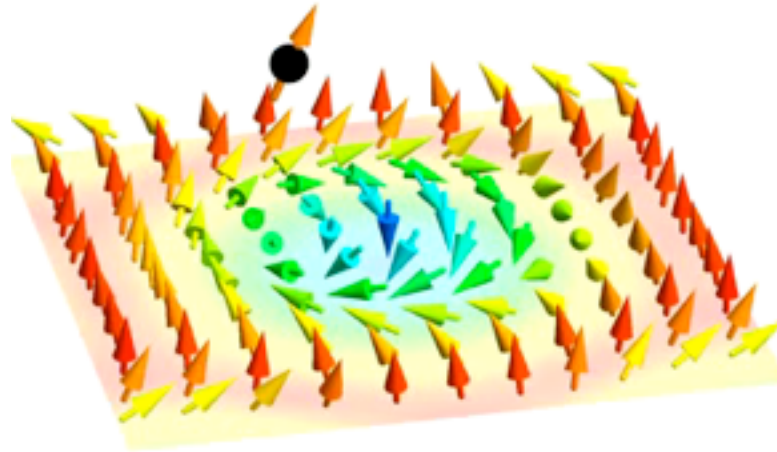

Emergent Electric Field due to Skyrmion Motion



standard 6-terminal
,no' T-gradient!

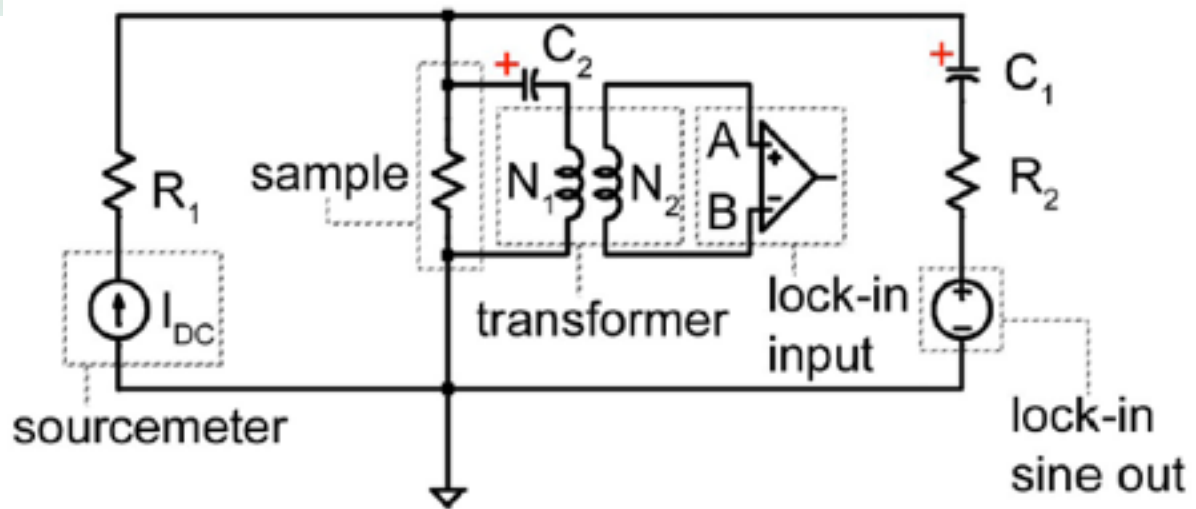

Emergent Electric Field due to Skyrmion Motion

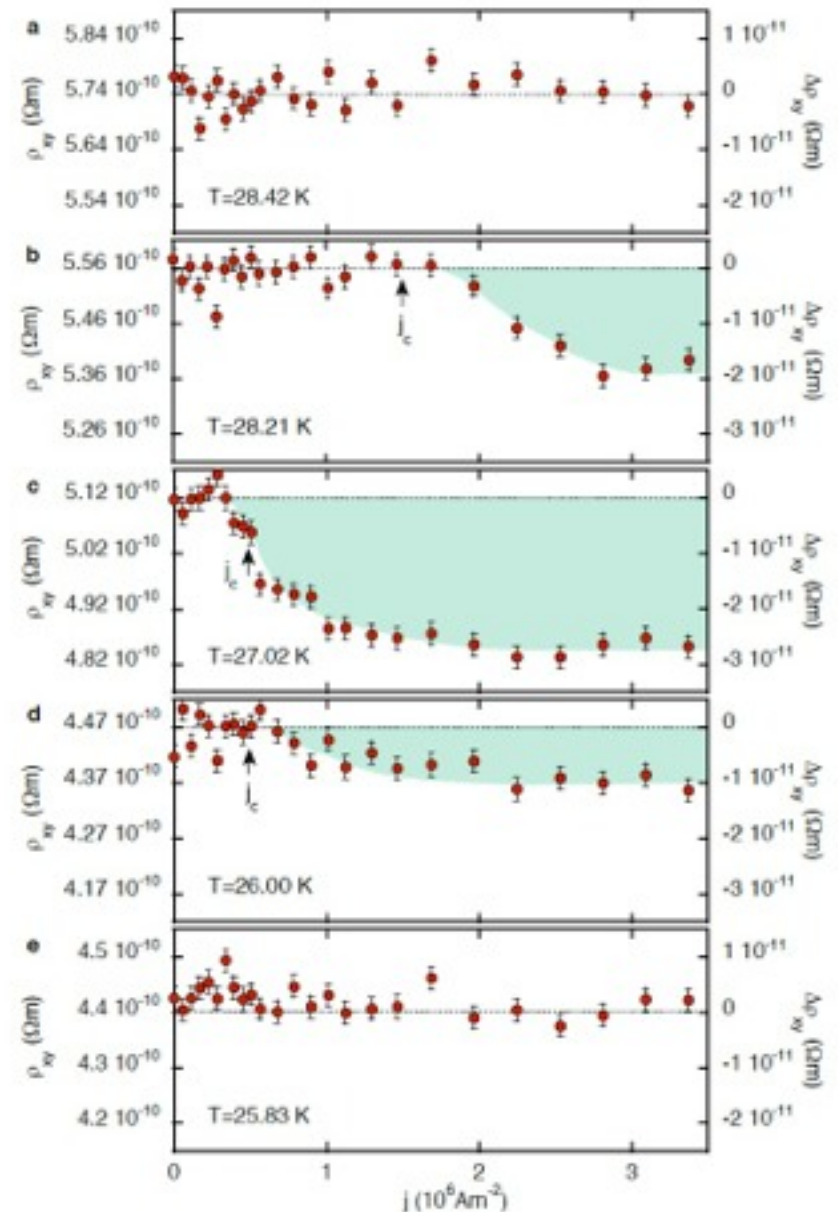
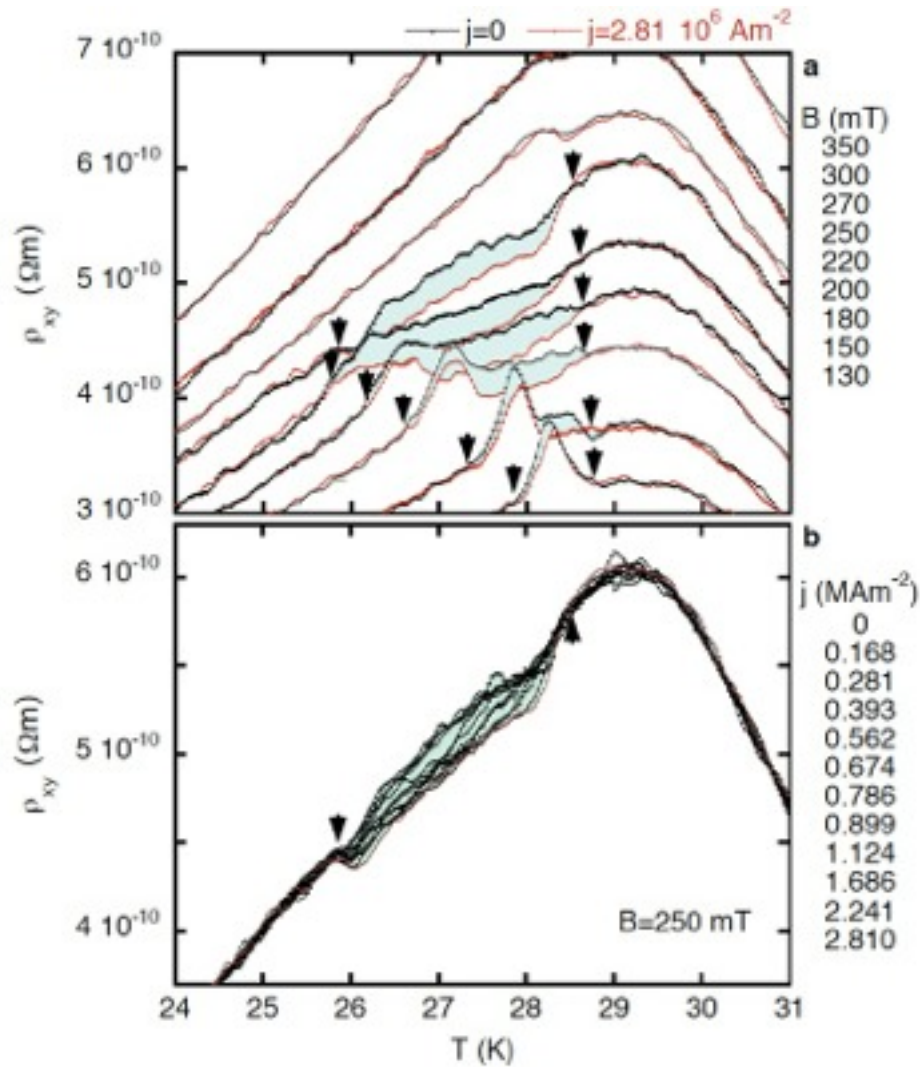

Emergent Electric Field due to Skyrmion Motion

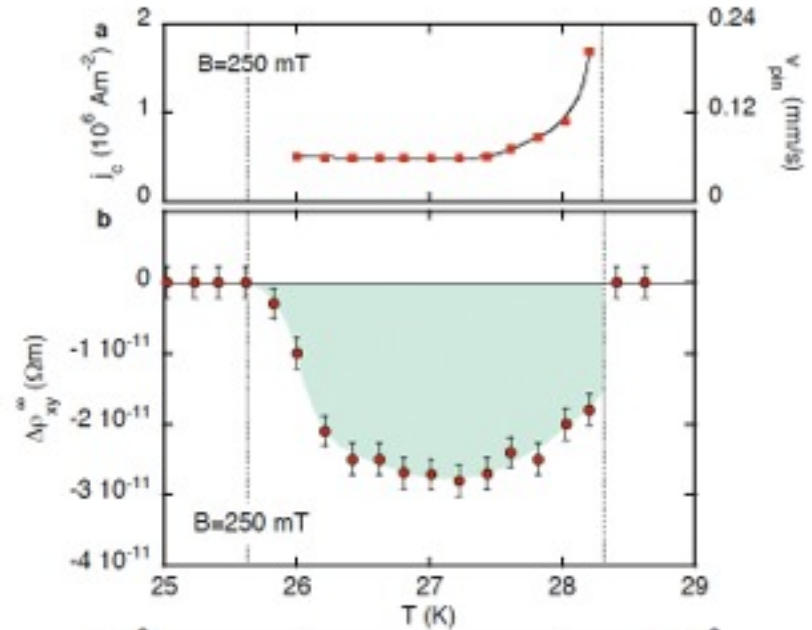
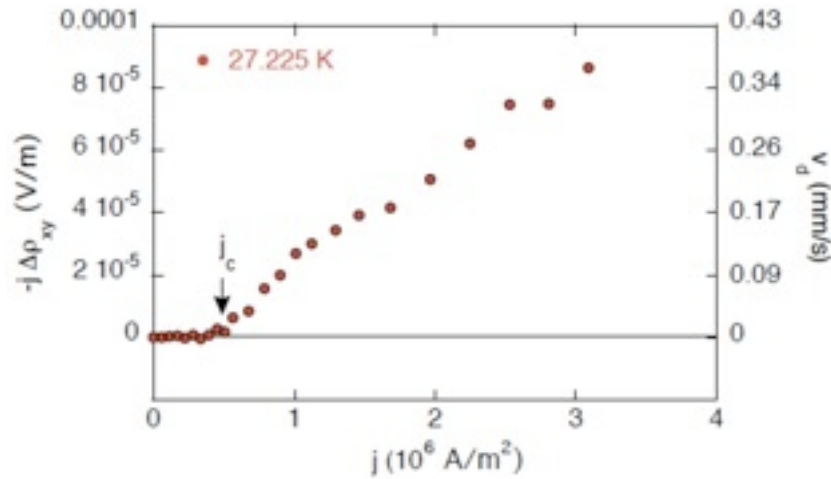

$$\mathbf{E}^e = -\mathbf{v}_d \times \mathbf{B}^e$$

$$v_{d\parallel} \approx - \left| \frac{e}{q^e} \right| \frac{j \Delta \rho_{xy}}{B^e \tilde{P}}$$

$$= v_{\text{pin}} \frac{j \Delta \rho_{xy}}{j_c \Delta \rho_{xy}^\infty}$$

$$\approx \frac{j}{10^6 \text{ Am}^{-2}} \frac{\Delta \rho_{xy}}{\Delta \rho_{xy}^\infty} 0.12 \frac{\text{mm}}{\text{s}}$$

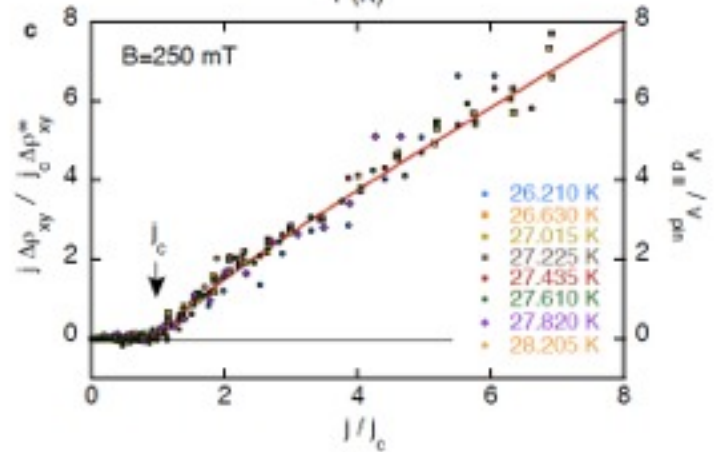

Perspectives & Summary

Magnetic Phase Diagram of B20 Compounds

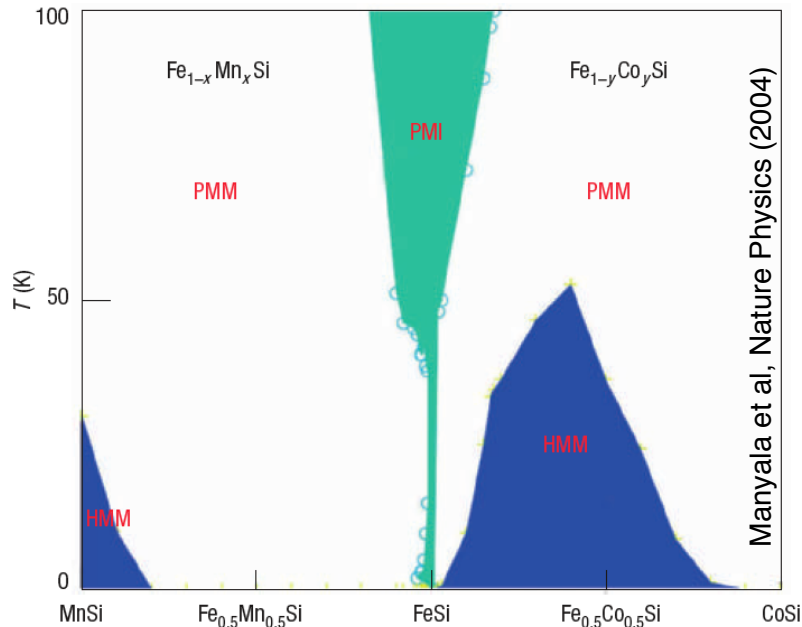

Mühlbauer, et al. Science **323**, 915 (2009)
 Neubauer, et al. PRL **102** 186602 (2009)
 Janoschek, et al. J. Phys. Conf. Series (2010)

Münzer, et al. PRB(R) **81** 041203 (2010)
 Adams, et al. J. Phys. Conf. Series (2010)
 Bauer, et al. PRB(R) **82** 064404 (2010)

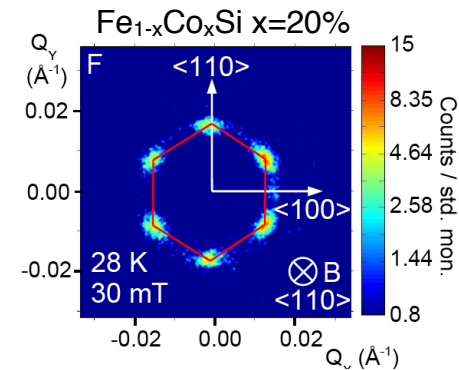
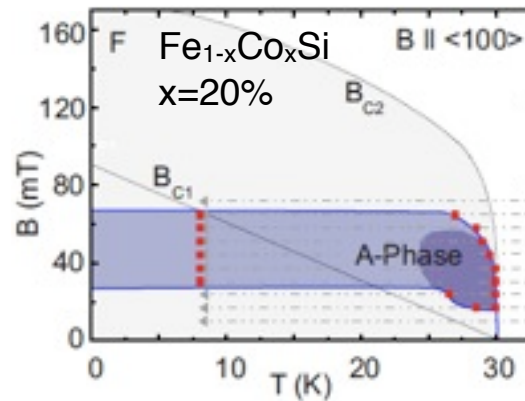
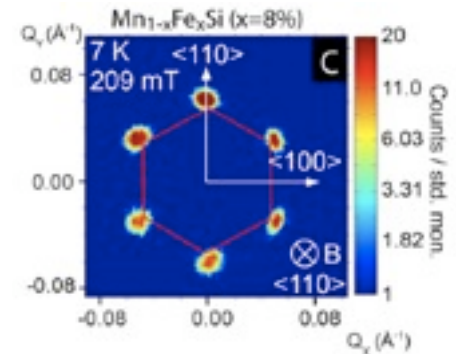
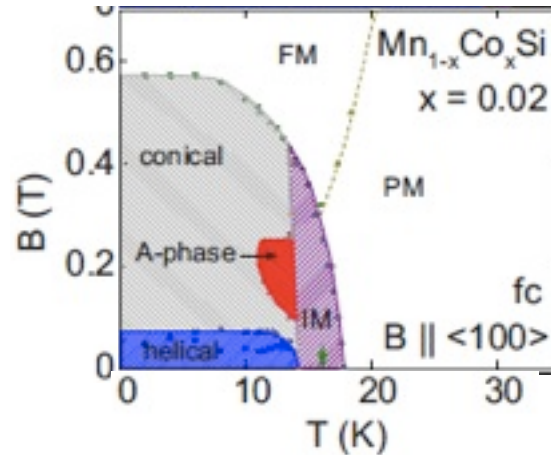

P2₁3 insulators Cu₂OSeO₃

Seki et al., Science **336** 198 (2012)
 Adams et al., PRL, **108** 237204 (2012)

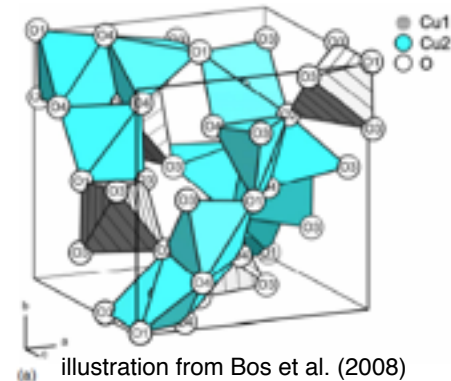

Real Space Observation with Lorentz Force Microscopy

individual skyrmions

near room temperature

in multiferroics

$\text{Fe}_{0.5}\text{Co}_{0.5}\text{Si}$

FeGe

Cu_2OSeO_3

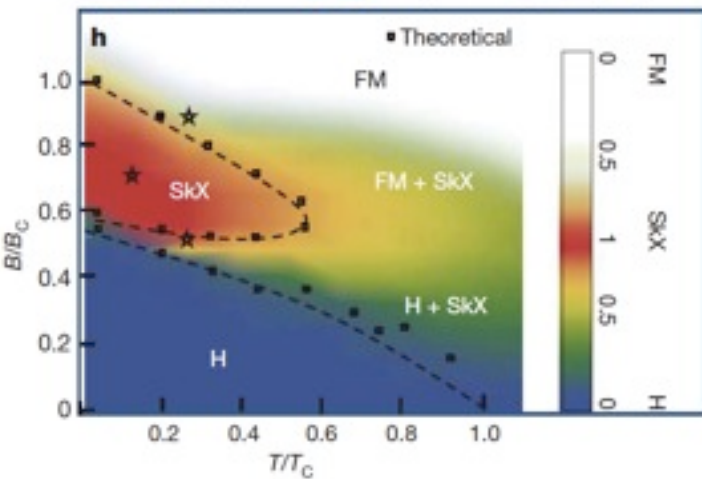
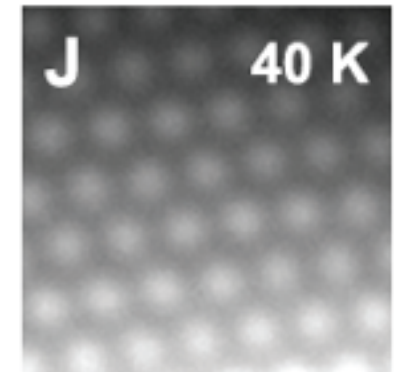
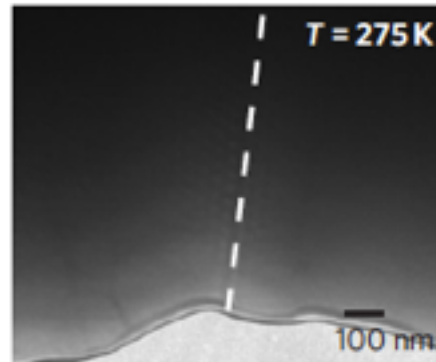
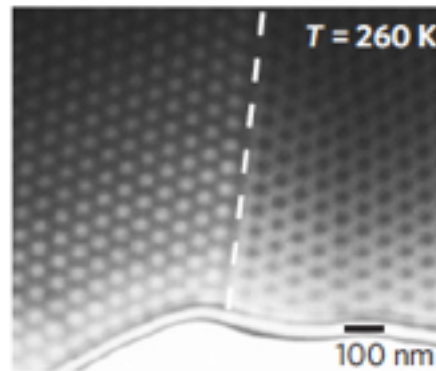
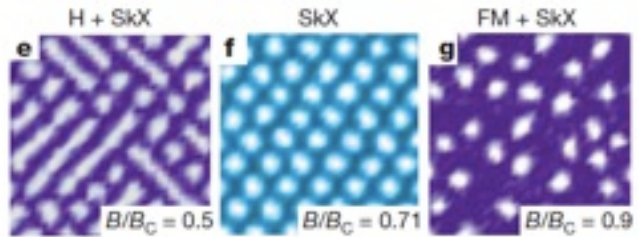

Münzer, et al. PRB(R) **81** 041203 (2010)

Yu et al., Nature **465** 901 (2010)

Yu et al., Nat. Mater. **10** 106 (2010)

Seki et al., Science **336** 198 (2012)

CP & Rosch, Nature (N&V) **465** 880 (2010)

Summary

Skyrmion Lattices in Chiral Magnets

- » basic phenomenology in MnSi
- » theoretical account
- » proof of topology

Emergent Electrodynamics

- » spin torque effects (SANS)
- » emergent magnetic field
- » topological Hall effect
- » emergent electric field

