

Milestones toward Majorana-based quantum computing

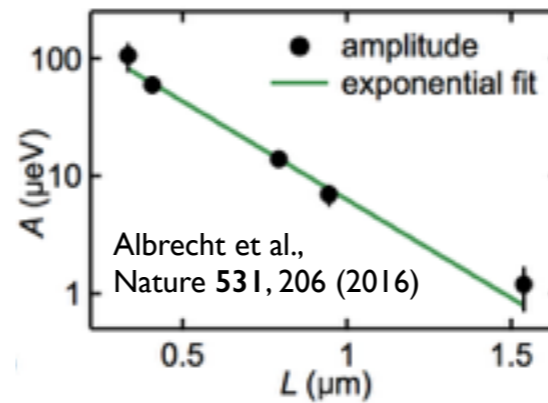

Majorana-based quantum computing

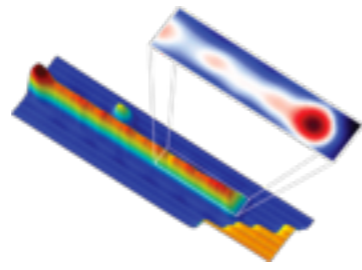
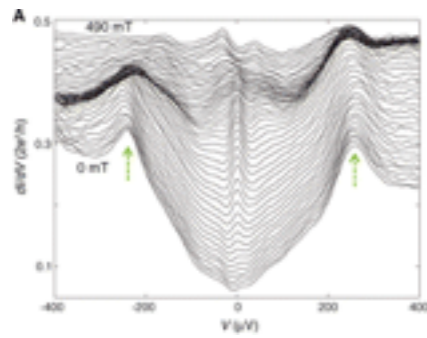
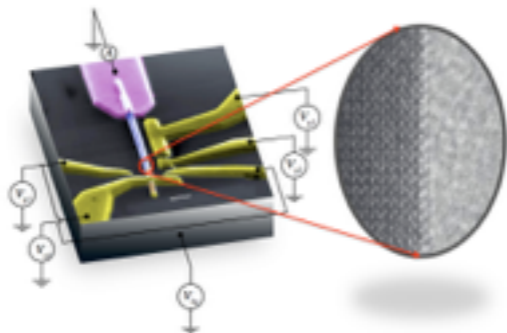
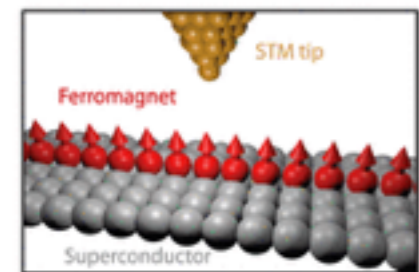
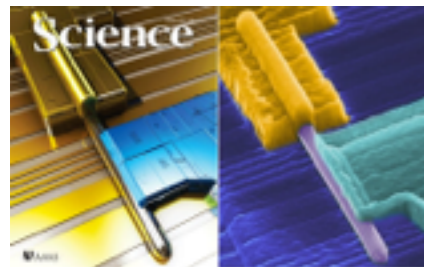
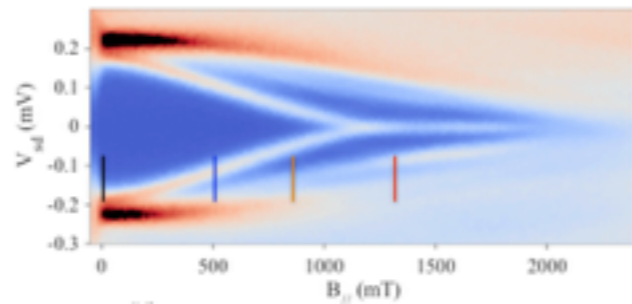

Device fabrication



Majorana signatures



Exponential degeneracy

“Majorana mountain”

Jason Alicea

(Caltech, IQIM, & Walter Burke Institute)



Dave Aasen
(current KITP grad fellow)



Michael Hell

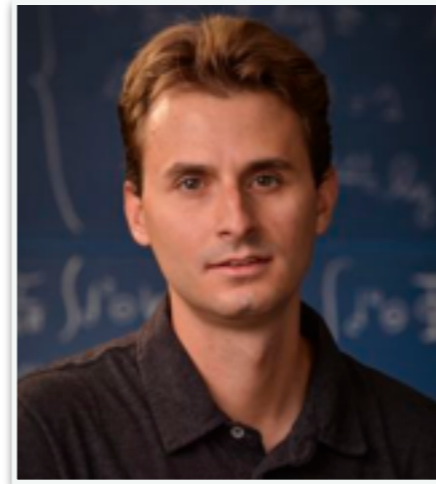

Ryan Mishmash

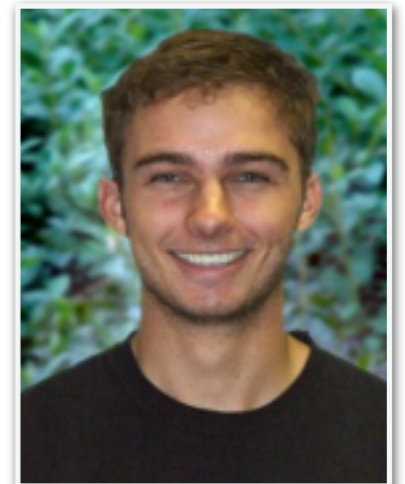

Andrew Higginbotham



Jeroen Danon



Martin Leijnse

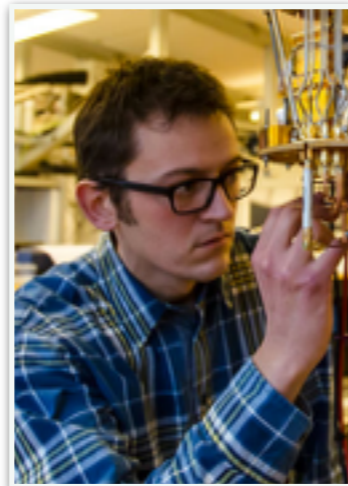

Thomas Jespersen



Josh Folk



Charlie Marcus



Karsten Flensberg

Physical Review X 6, 031016 (2016)



(Ising) non-Abelian anyons

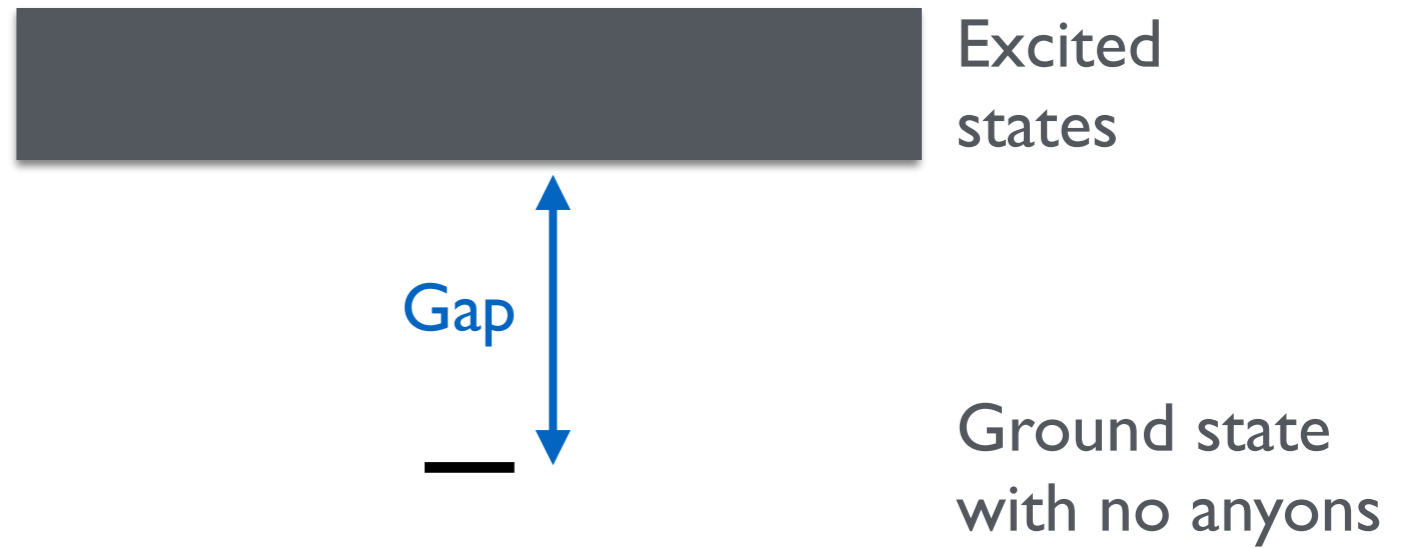

(Ising) non-Abelian anyons

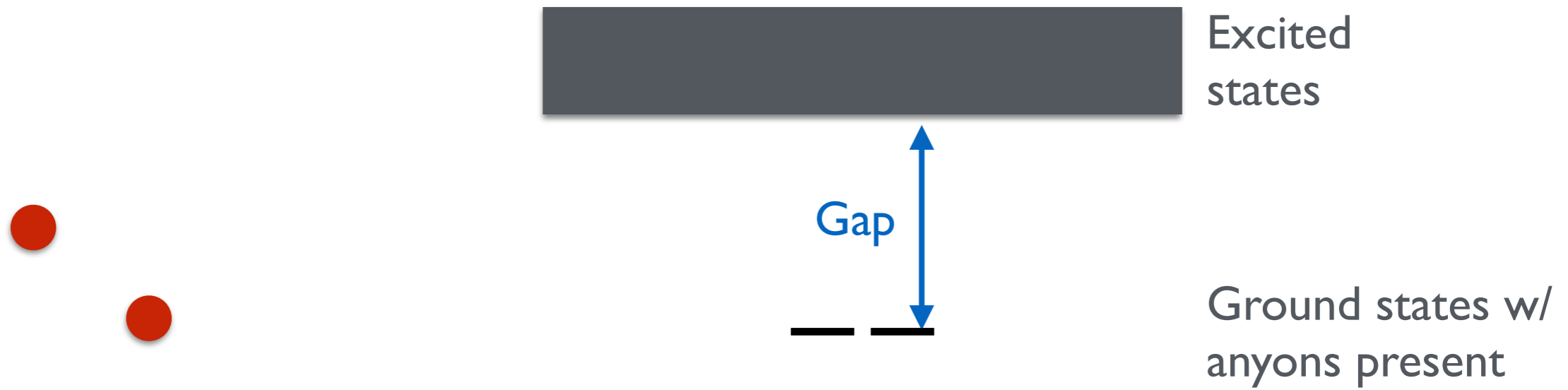

(Ising) non-Abelian anyons

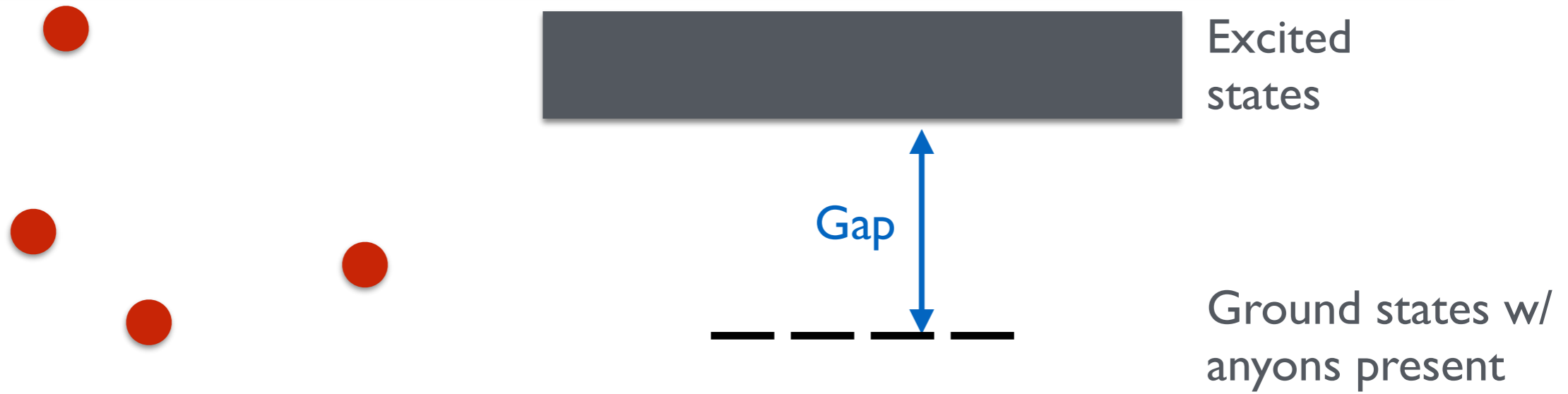

(Ising) non-Abelian anyons



(Ising) non-Abelian anyons

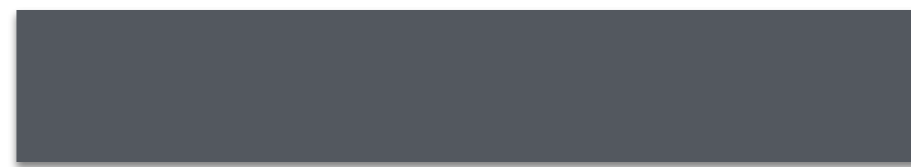
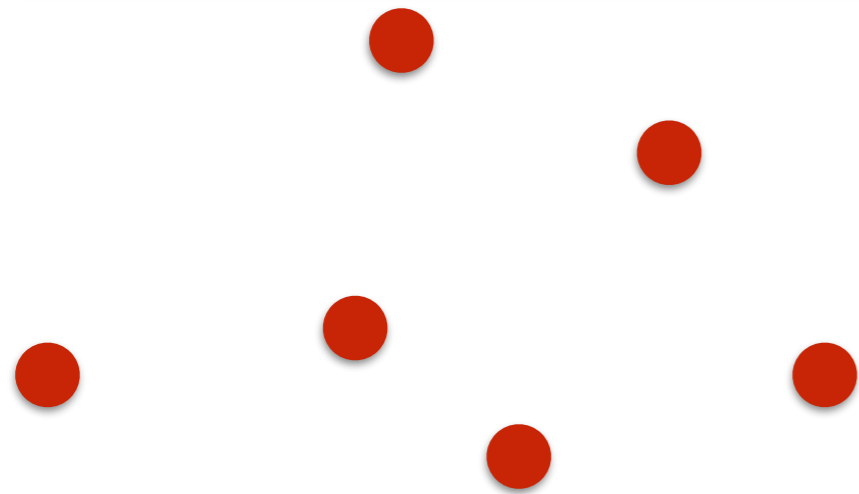

Excited states



Ground states w/
anyons present

But what about, say, free spin-1/2's?

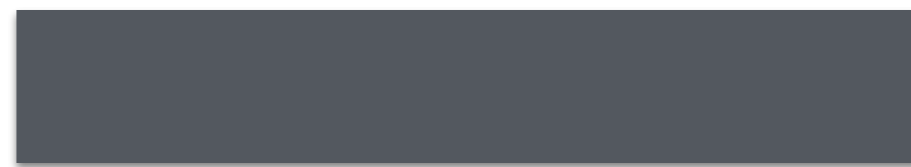
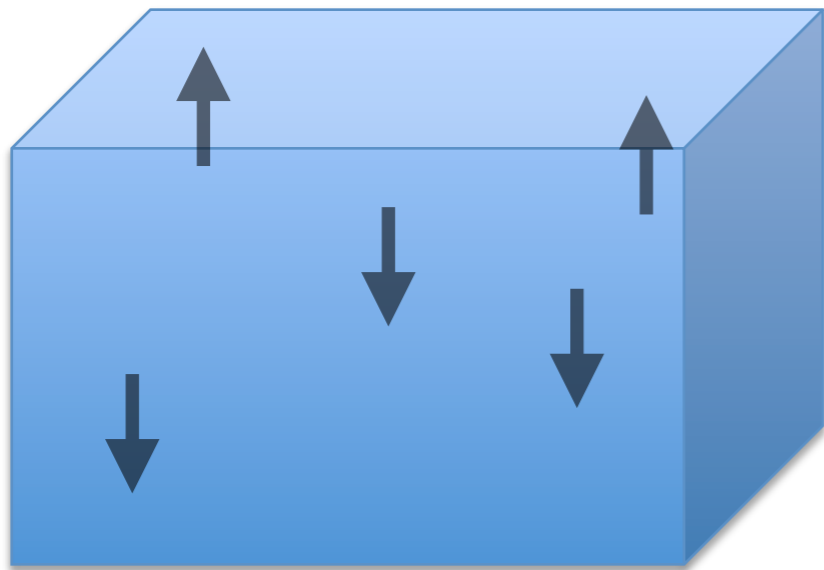

(Ising) non-Abelian anyons

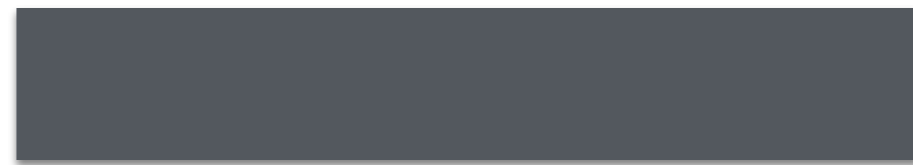
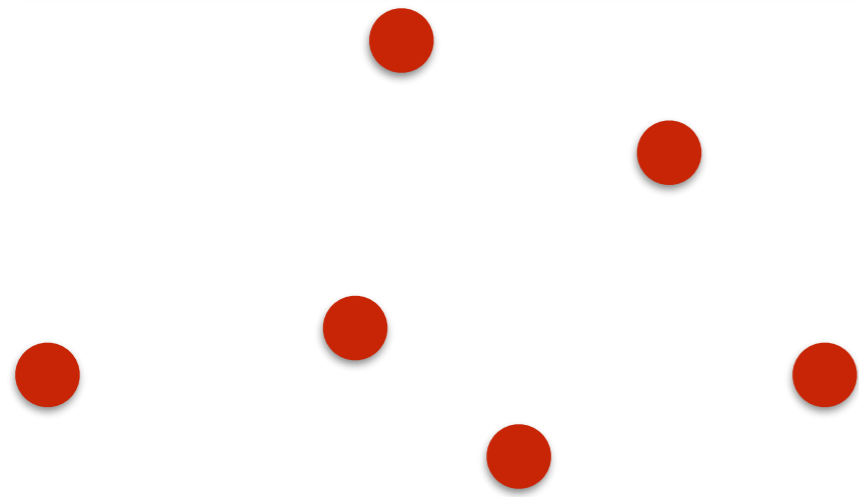

Excited states



Ground states w/
anyons present

But what about, say, free spin-1/2's?

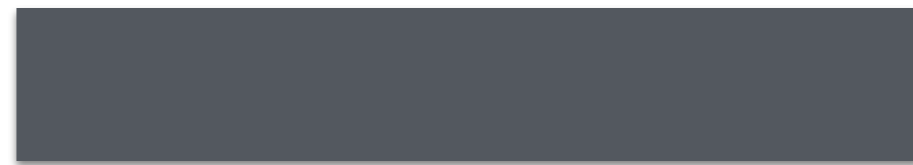
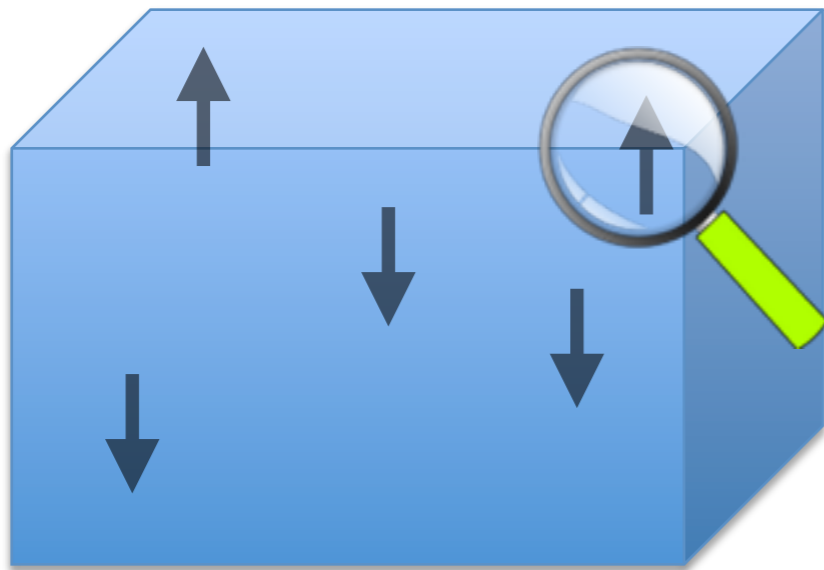

(Ising) non-Abelian anyons

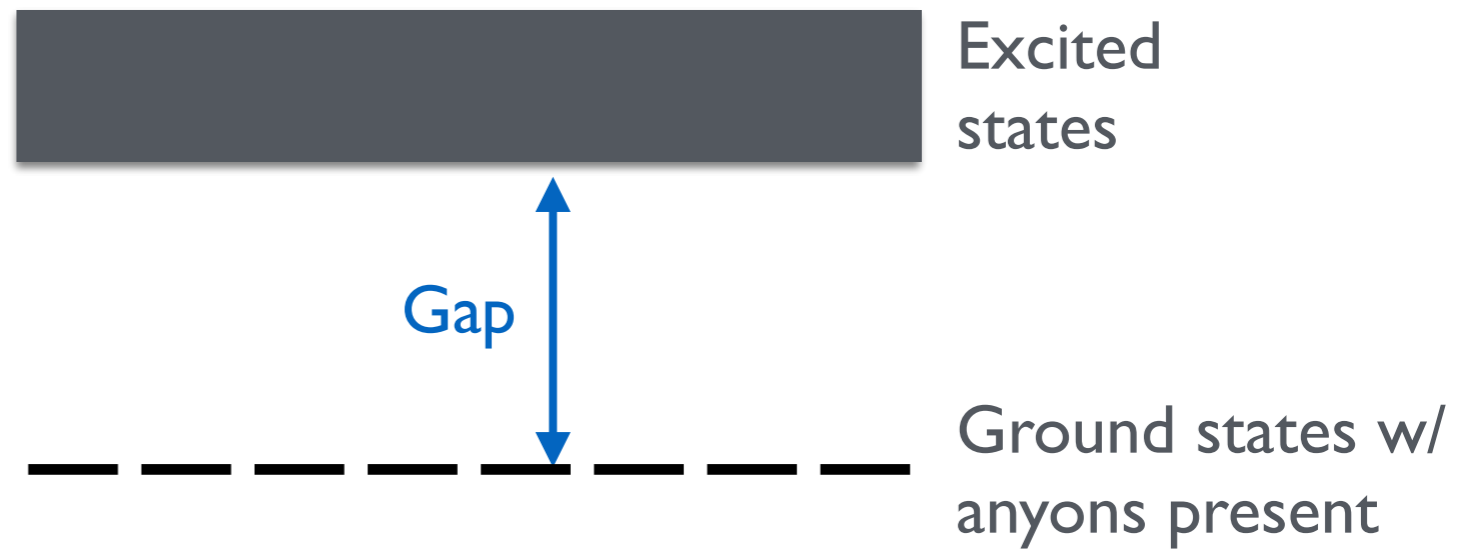
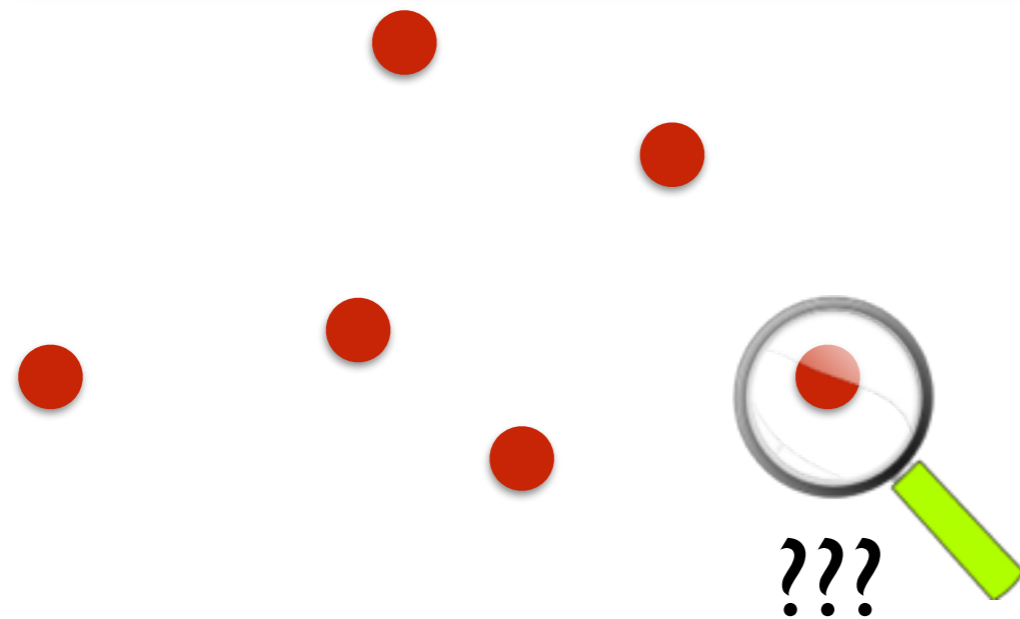

But what about, say, free spin-1/2's?

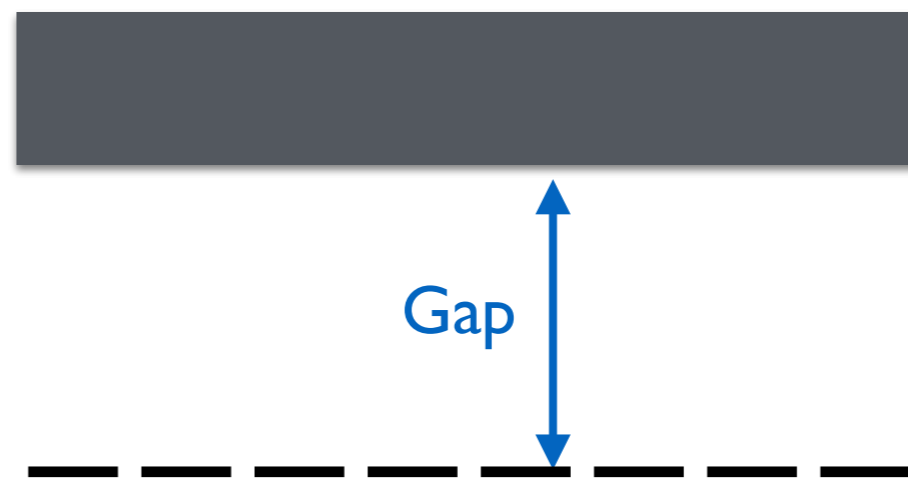
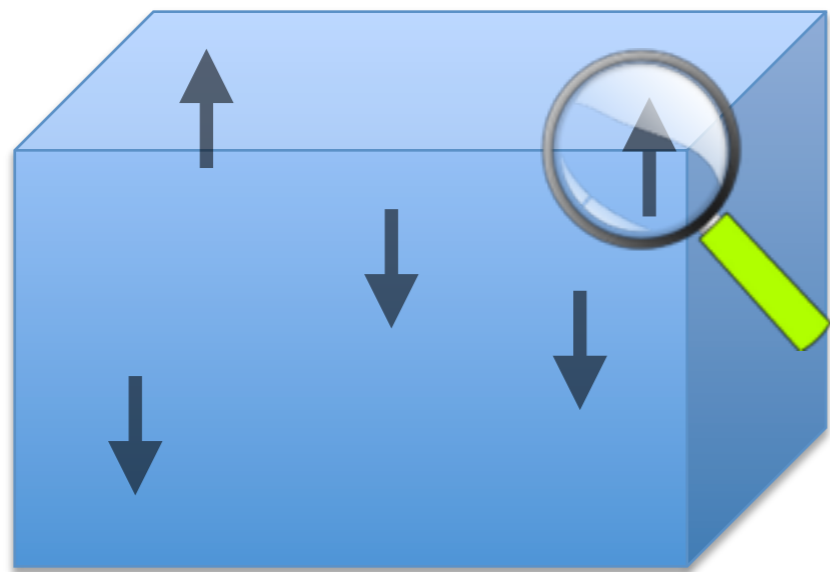

(Ising) non-Abelian anyons

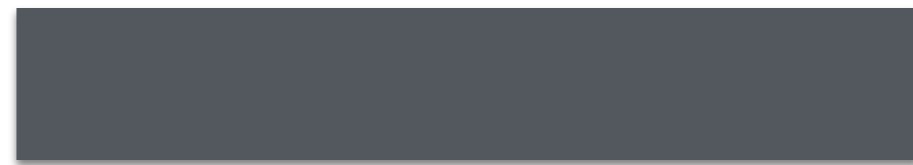
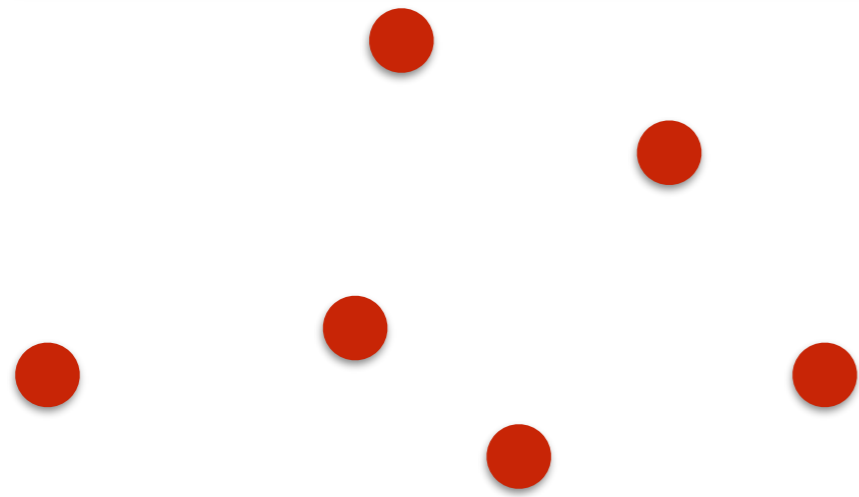

Excited states



Ground states w/
anyons present

But what about, say, free spin-1/2's?

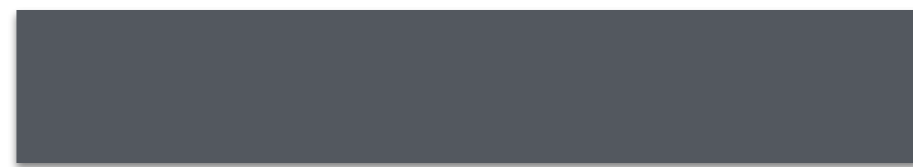
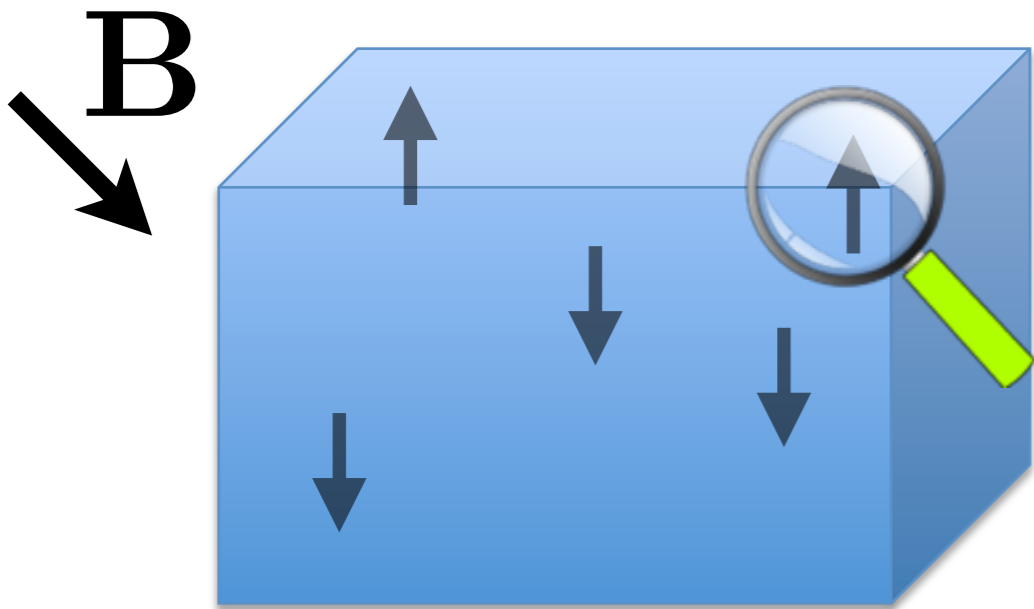

(Ising) non-Abelian anyons

B

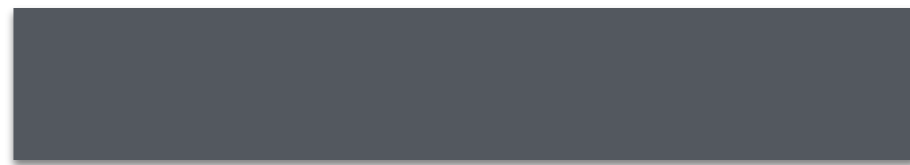
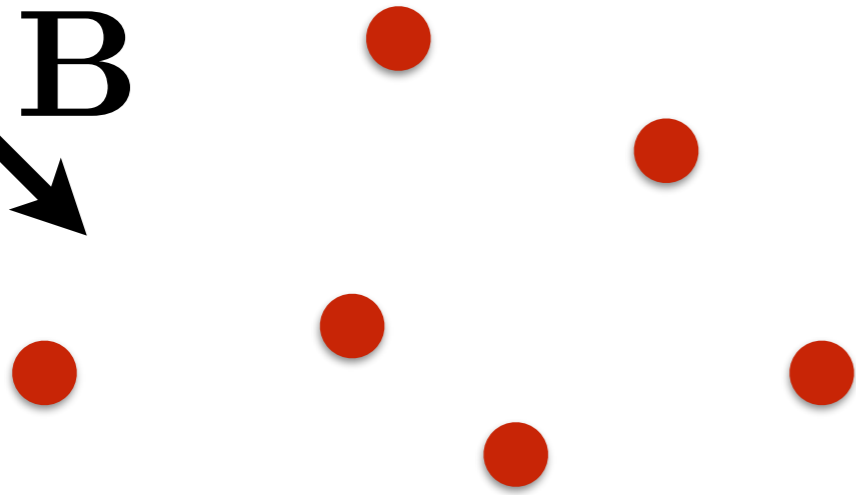

Excited states

Gap



Ground states w/
anyons present

But what about, say, free spin-1/2's?

B

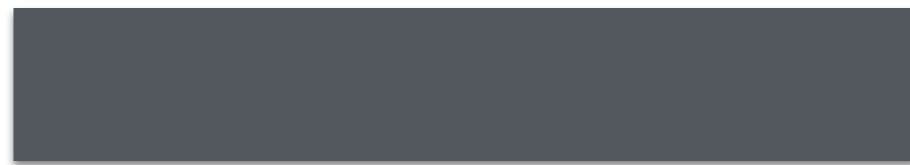
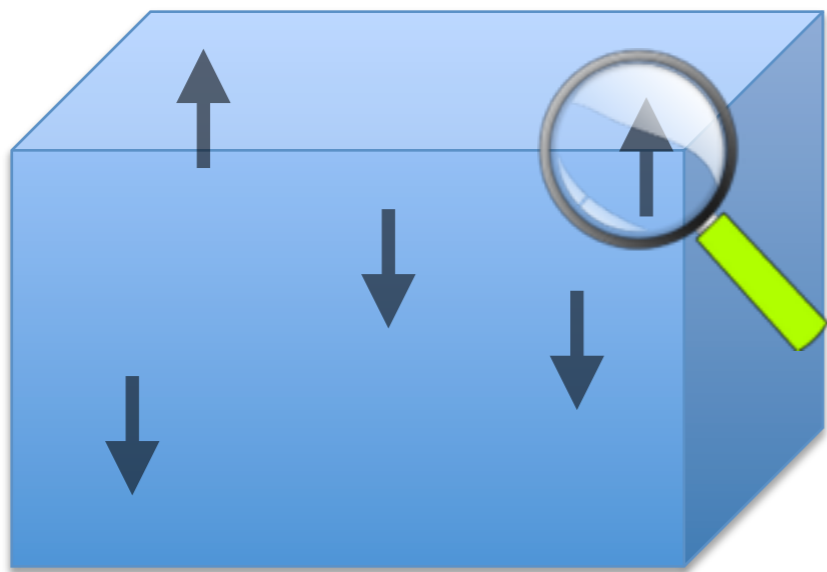

(Ising) non-Abelian anyons



(Ising) non-Abelian anyons



$$\phi_i$$

(Ising) non-Abelian anyons



$$\phi_i$$

(Ising) non-Abelian anyons

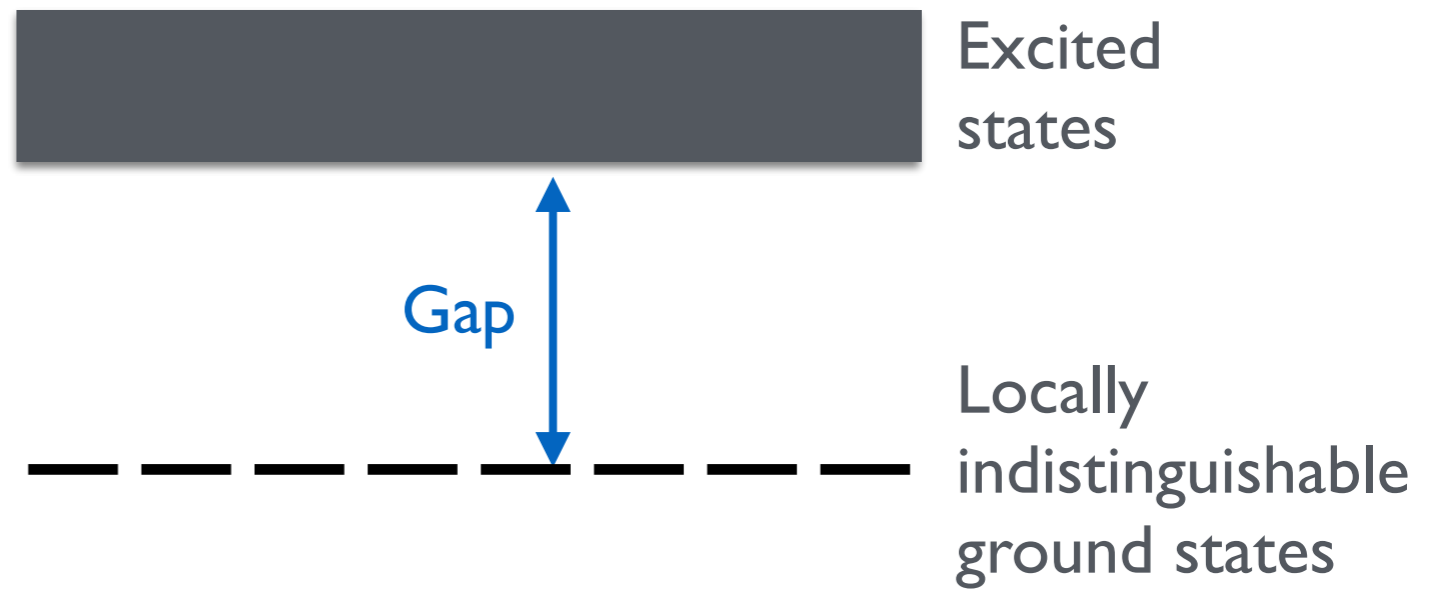
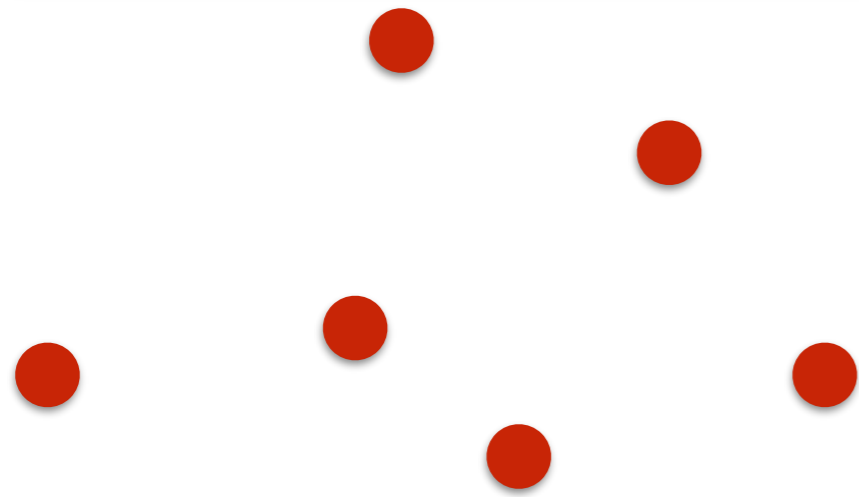

Non-Abelian statistics

$$\phi_i \rightarrow U_{ij} \phi_j$$

(Ising) non-Abelian anyons

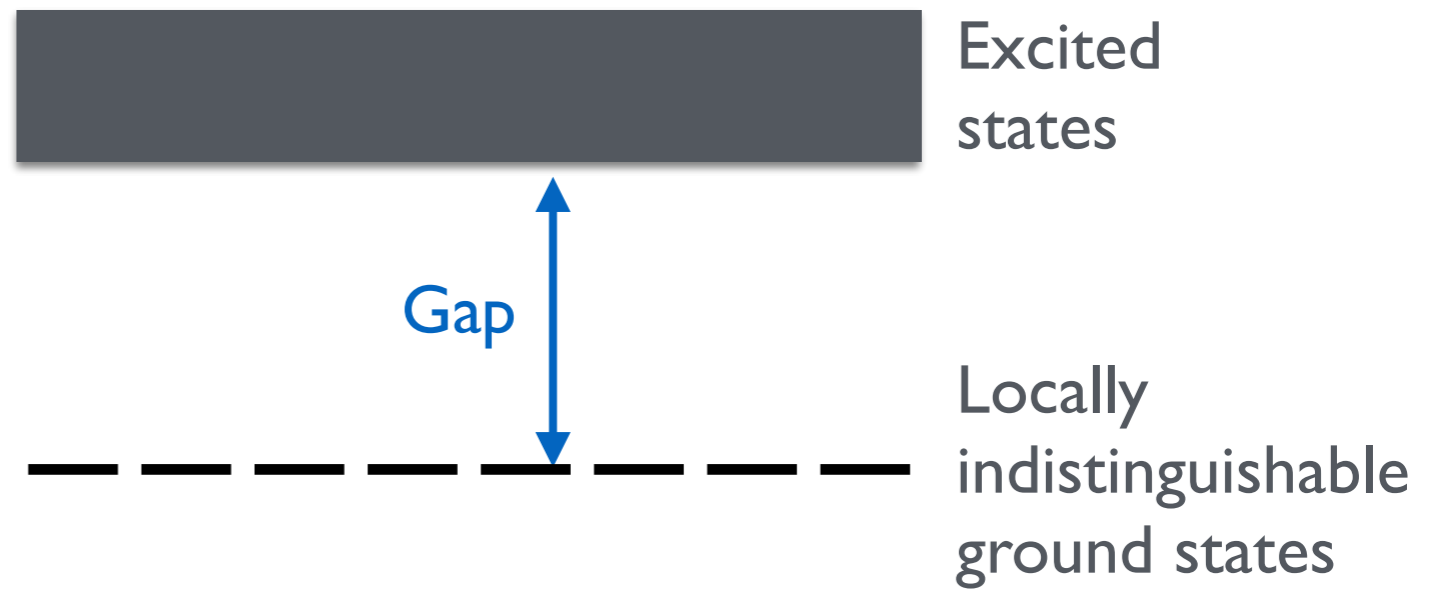
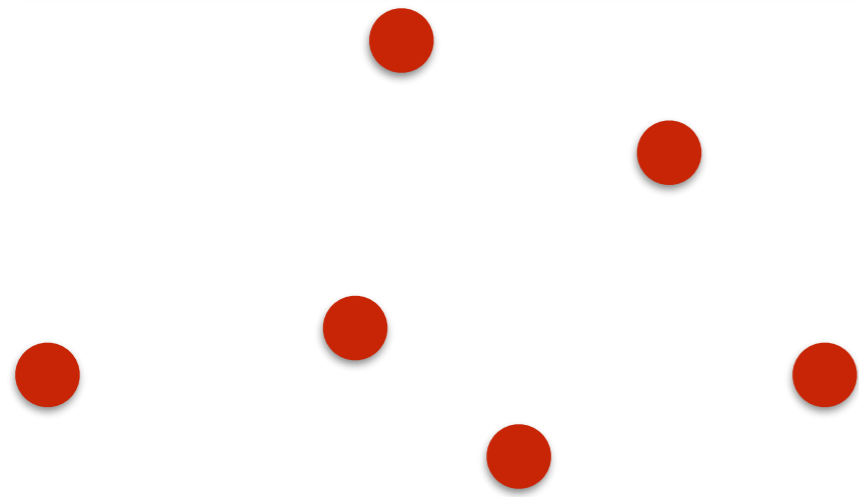

Non-Abelian statistics

$$\phi_i \rightarrow U_{ij} \phi_j$$



Nontrivial fusion rules

$$\sigma \times \sigma = I + \psi$$

— ψ
— I

(Ising) non-Abelian anyons

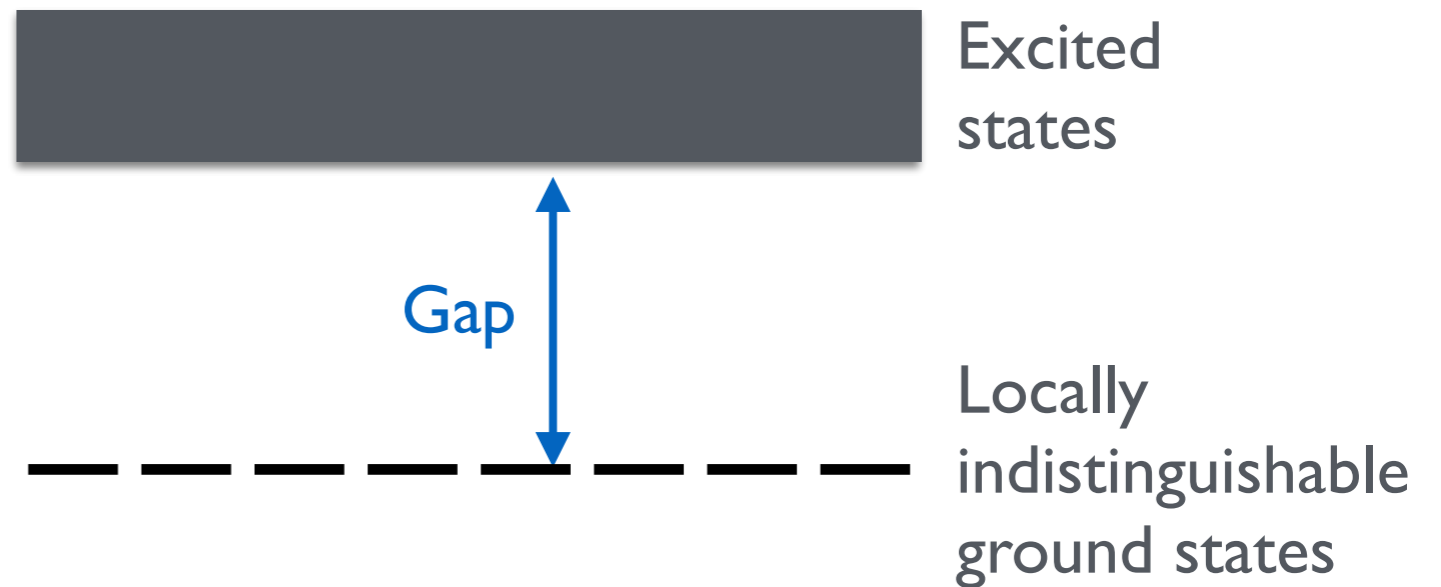
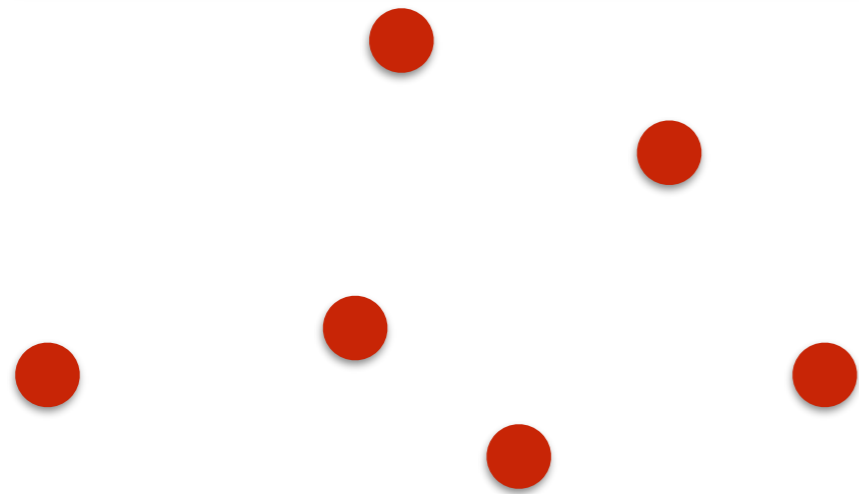

Non-Abelian statistics

$$\phi_i \rightarrow U_{ij} \phi_j$$



Nontrivial fusion rules

$$\sigma \times \sigma = I + \psi$$

— ψ

— I

(Ising) non-Abelian anyons

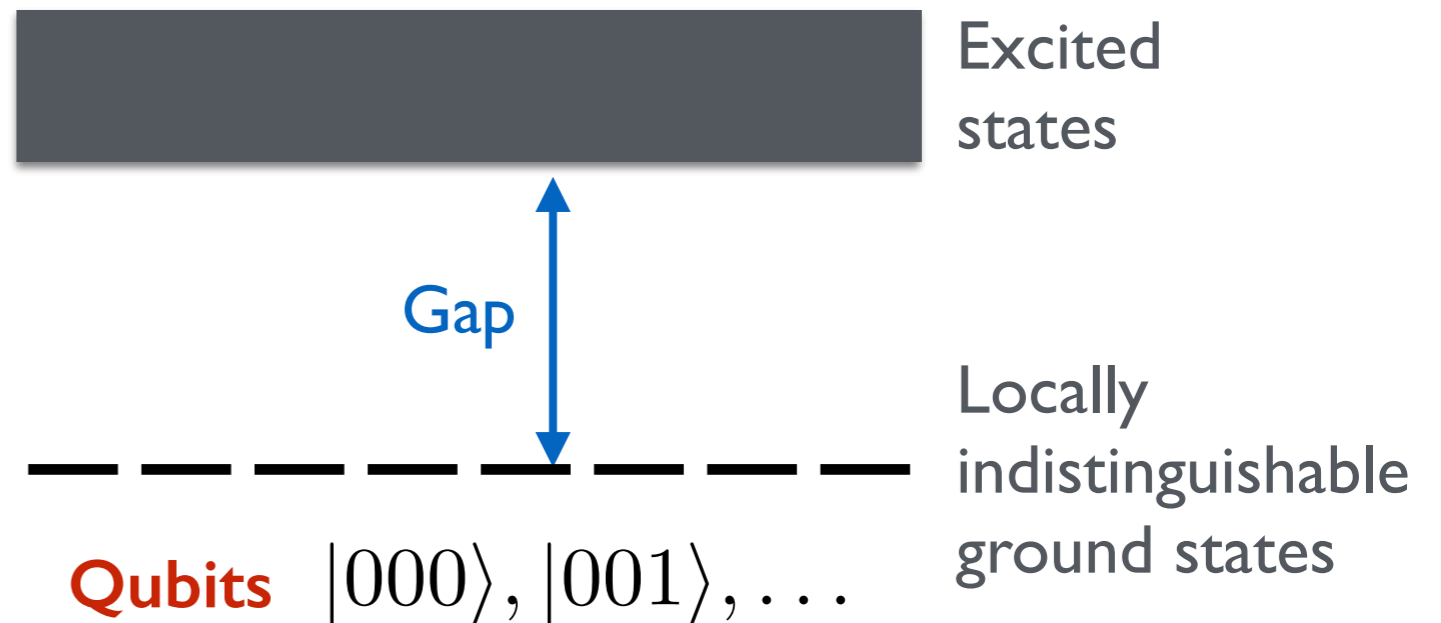
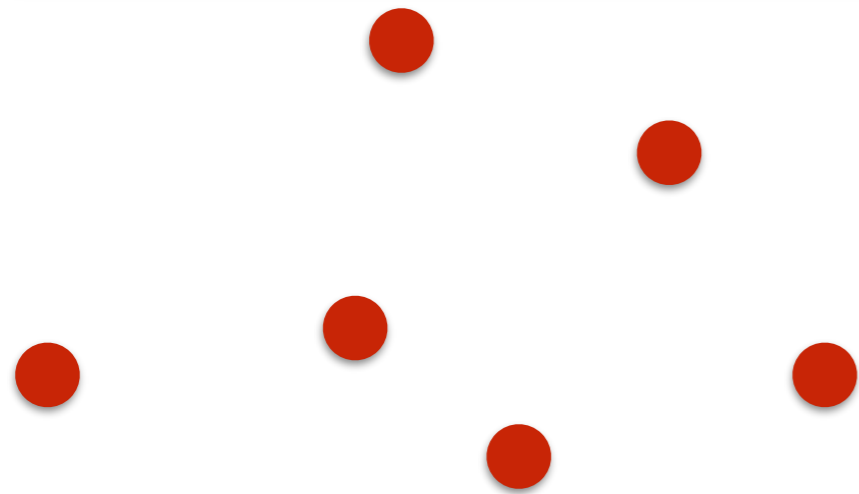

Non-Abelian statistics

$$\phi_i \rightarrow U_{ij} \phi_j$$

Quantum gates

Nontrivial fusion rules

$$\sigma \times \sigma = I + \psi$$

— ψ

— I

Readout

‘\$3 million idea’: fault-tolerant topological quantum computation!



Alexei Kitaev

(Ising) non-Abelian anyons

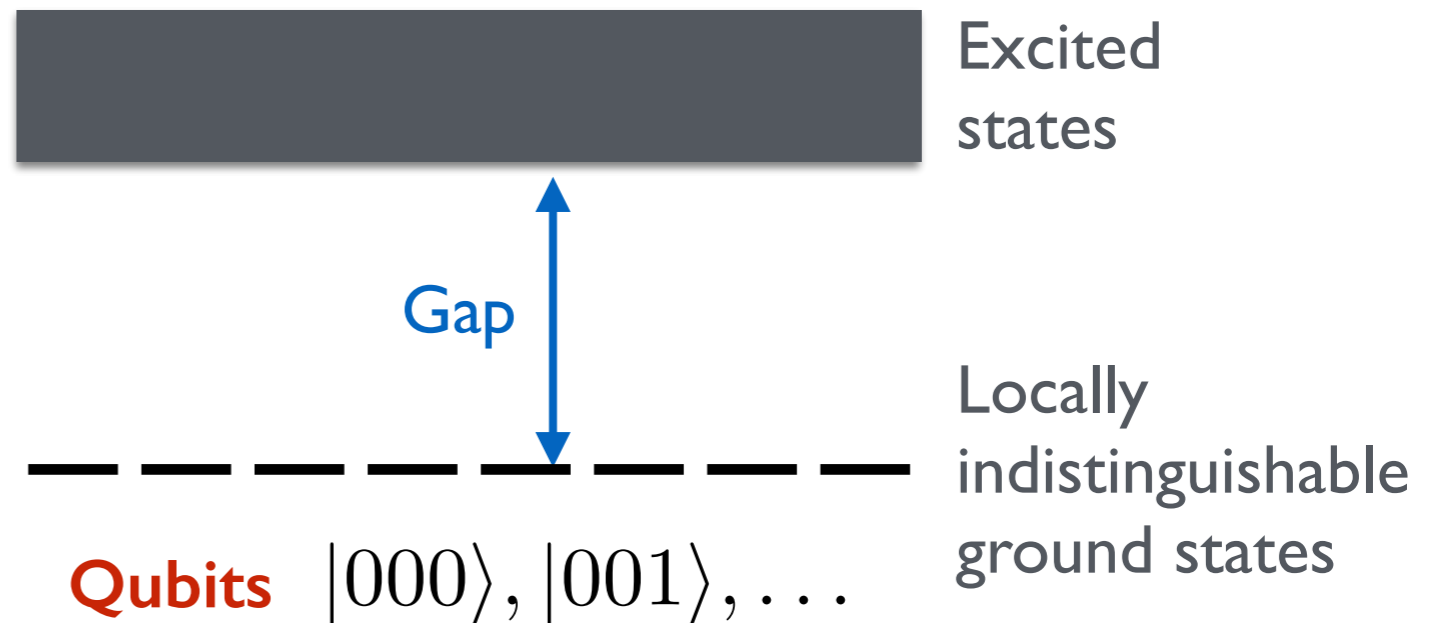
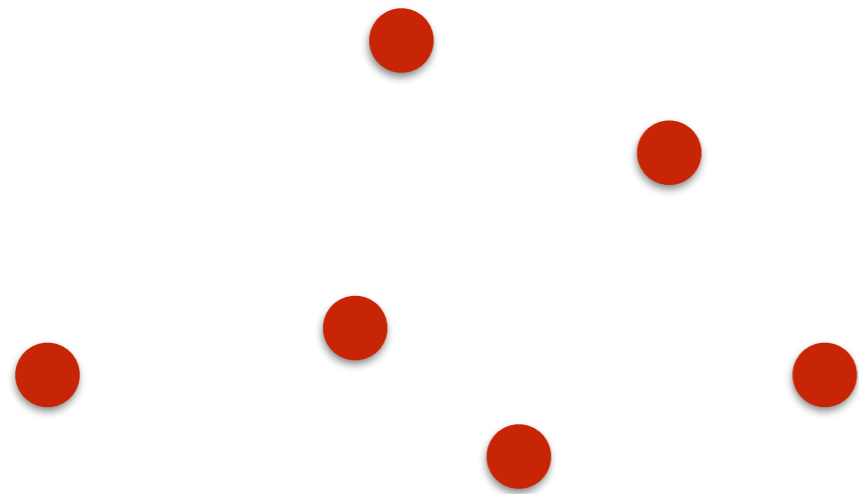

Non-Abelian statistics

$$\phi_i \rightarrow U_{ij} \phi_j$$

Quantum gates

Nontrivial fusion rules

$$\sigma \times \sigma = I + \psi$$

$\text{---} \psi$
 $\text{---} I$

Readout

'\$3 million idea': fault-tolerant topological quantum computation!

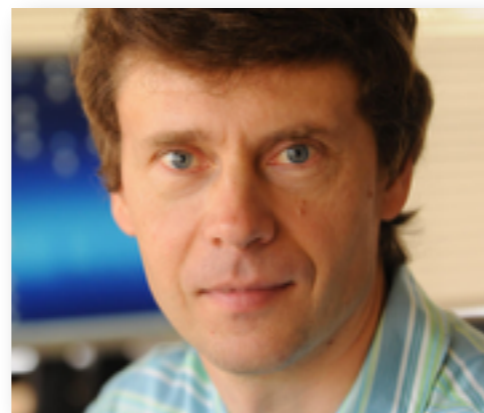

Alexei Kitaev

Billion \$ question: how to build the hardware?

Inception (late 80's)

Moore & Seiberg, Witten, ...

Inception (late 80's)

Moore & Seiberg, Witten, ...

Realizations
(1991-2000's)

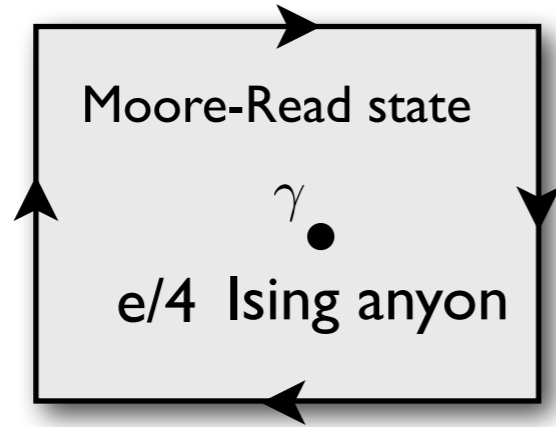

Moore & Read (1991)

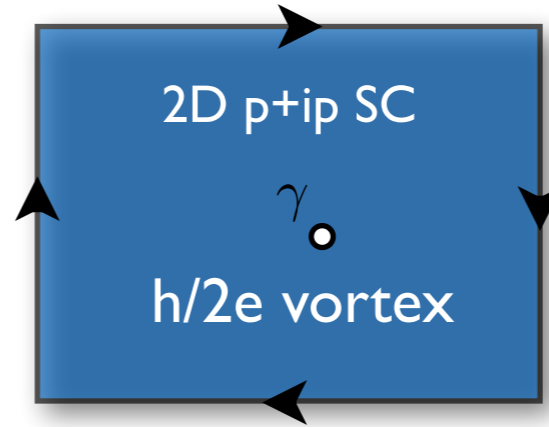

Read & Green (2000)



Inception (late 80's)

Moore & Seiberg, Witten, ...

Realizations
(1991-2000's)

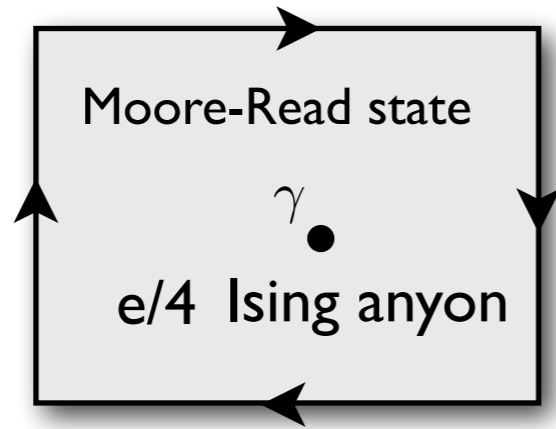

Moore & Read (1991)

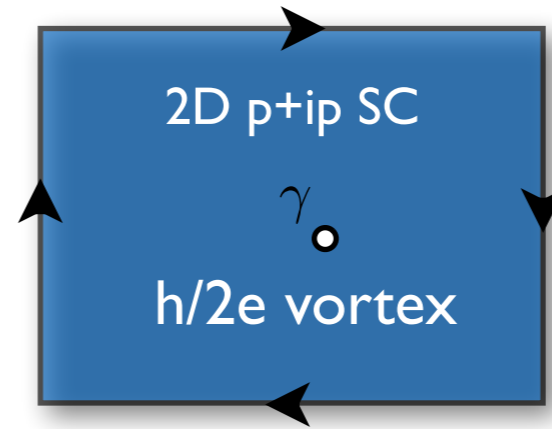

Read & Green (2000)

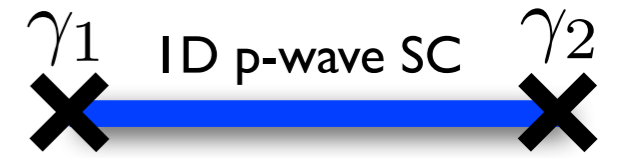

Kitaev (2001)

Design era
(2008-2012)

(many others)

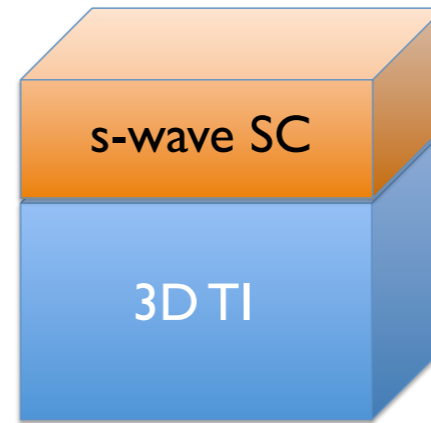

Fu & Kane (2008)

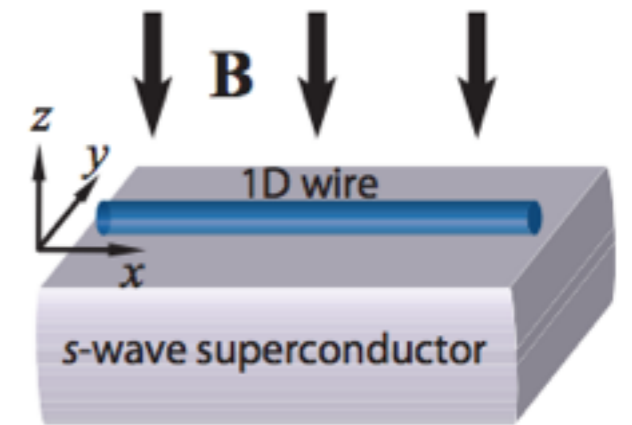

Lutchyn et al., Oreg et al. (2010)

Inception (late 80's)

Moore & Seiberg, Witten, ...

Realizations (1991-2000's)

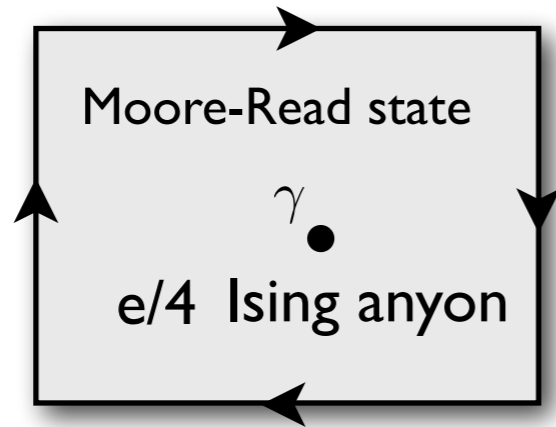

Moore & Read (1991)

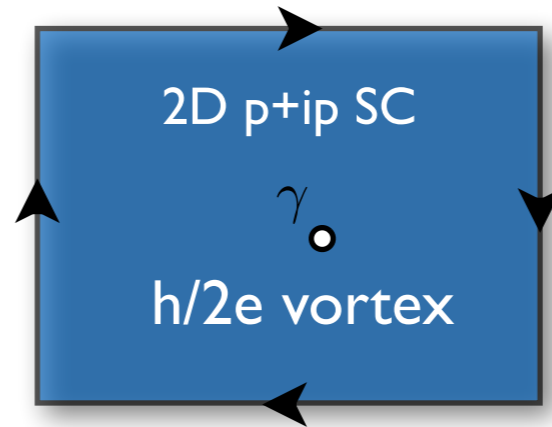

Read & Green (2000)

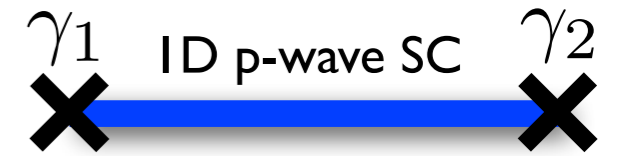

Kitaev (2001)

Design era (2008-2012)

(many others)

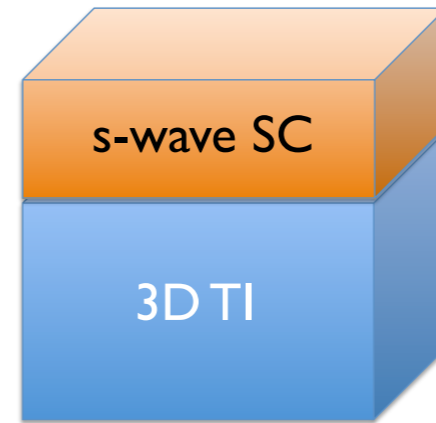

Fu & Kane (2008)

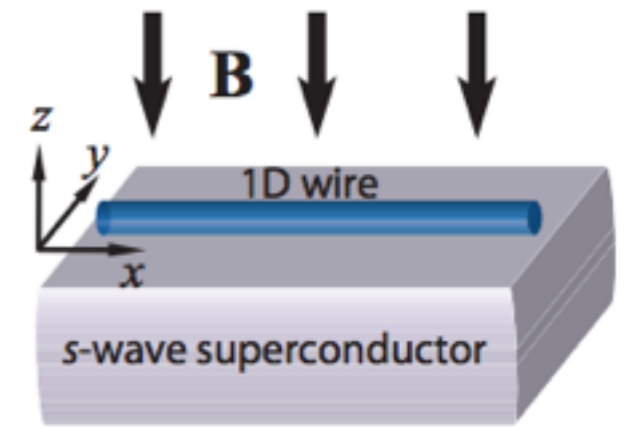

Lutchyn et al., Oreg et al. (2010)

Fabrication & characterization era (2012-present)

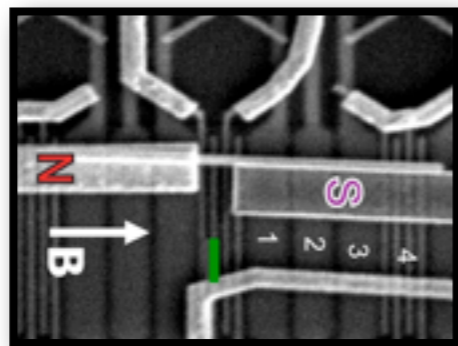

Mourik et al. (2012)

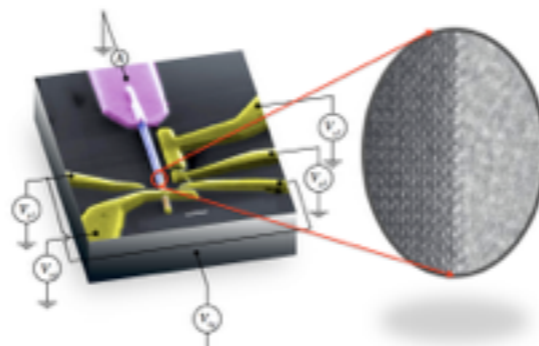

Marcus et al.

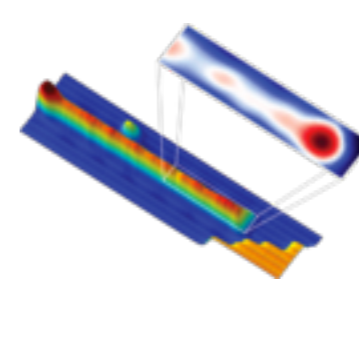

Nadj-Perge et al.

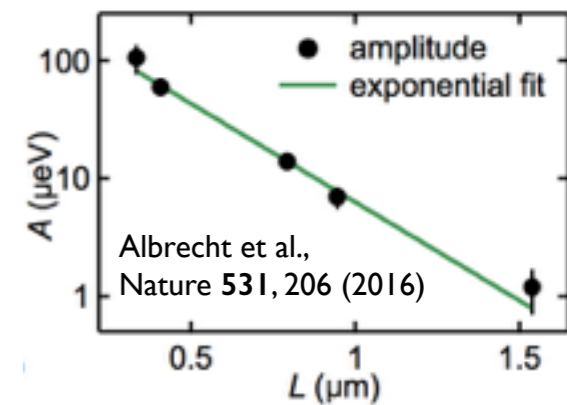

(many others)

Inception (late 80's)

Moore & Seiberg, Witten, ...

Realizations (1991-2000's)

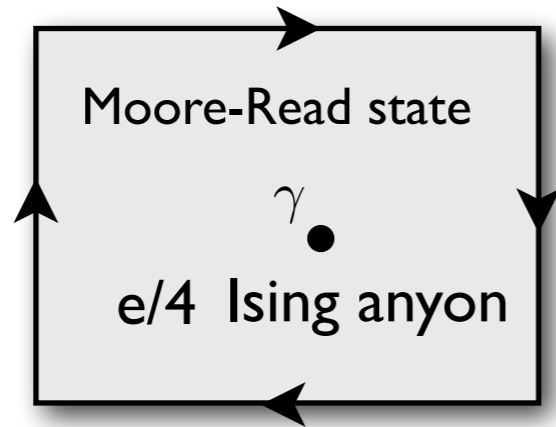

Moore & Read (1991)

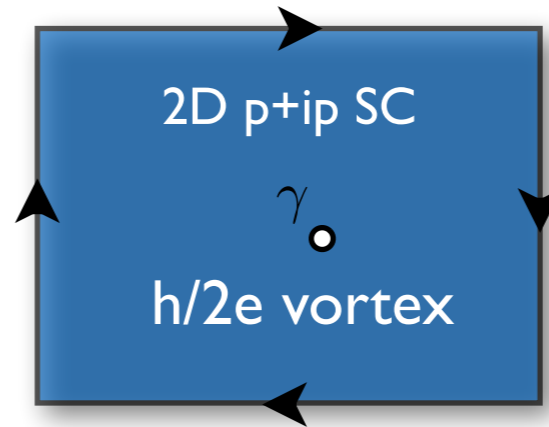

Read & Green (2000)

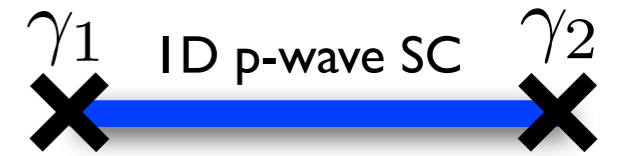

Kitaev (2001)

Design era (2008-2012)

(many others)

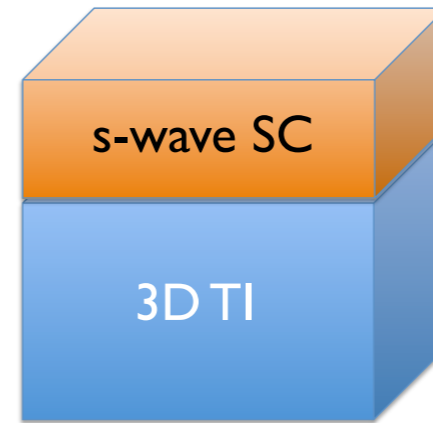

Fu & Kane (2008)

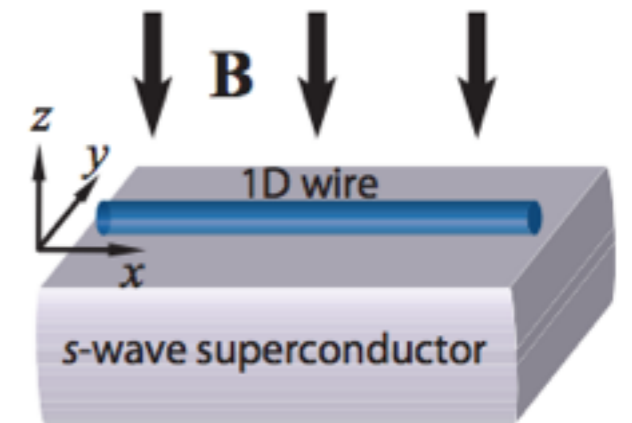

Lutchyn et al., Oreg et al. (2010)

Fabrication & characterization era (2012-present)

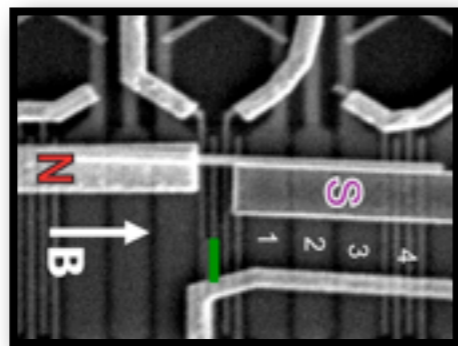

Mourik et al. (2012)

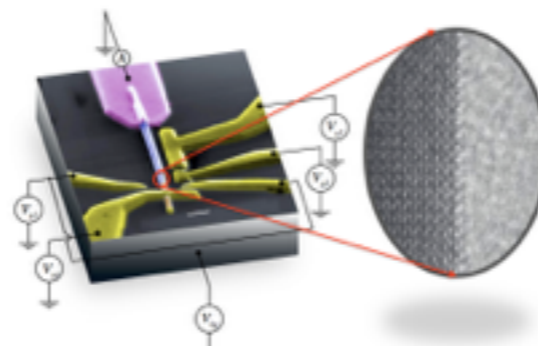

Marcus et al.

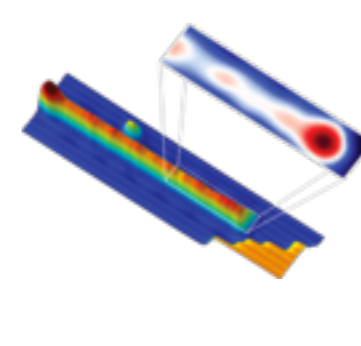

Nadj-Perge et al.

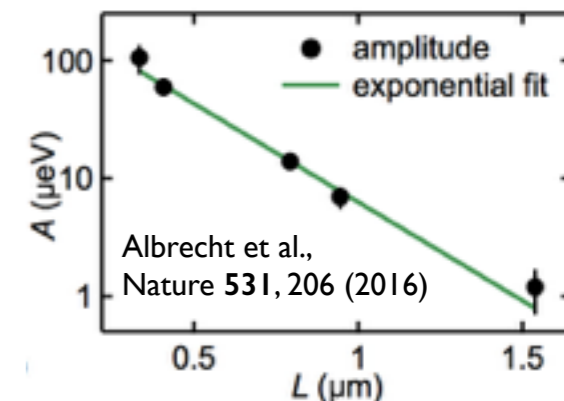

Albrecht et al., Nature 531, 206 (2016)

(many others)

Majorana control era (coming soon?)

I. New all-electrical Majorana control scheme

II. Majorana-control milestones



I. New all-electrical Majorana control scheme

Goal: leverage quantum dot/spin qubit tools for experiments below

II. Majorana-control milestones



Related to T.W. Larsen, K. D. Petersson, F. Kuemmeth, T. S. Jespersen, P. Krogstrup, J. Nygard, and C. M. Marcus, PRL 115, 127001 (2015); G. de Lange, B. van Heck, A. Bruno, D. J. van Woerkom, A. Geresdi, S. R. Plissard, E. P.A. M. Bakkers, A. R. Akhmerov, and L. DiCarlo, PRL 115, 127002 (2015); B. van Heck, A. R. Akhmerov, F. Hassler, M. Burrello, and C.W.J. Beenakker, New Journal of Physics 14, 035019 (2012); T. Hyart, B. van Heck, I. C. Fulga, M. Burrello, A. R. Akhmerov, and C.W.J. Beenakker, Phys. Rev. B 88, 035121 (2013).

Majorana control scheme: setup

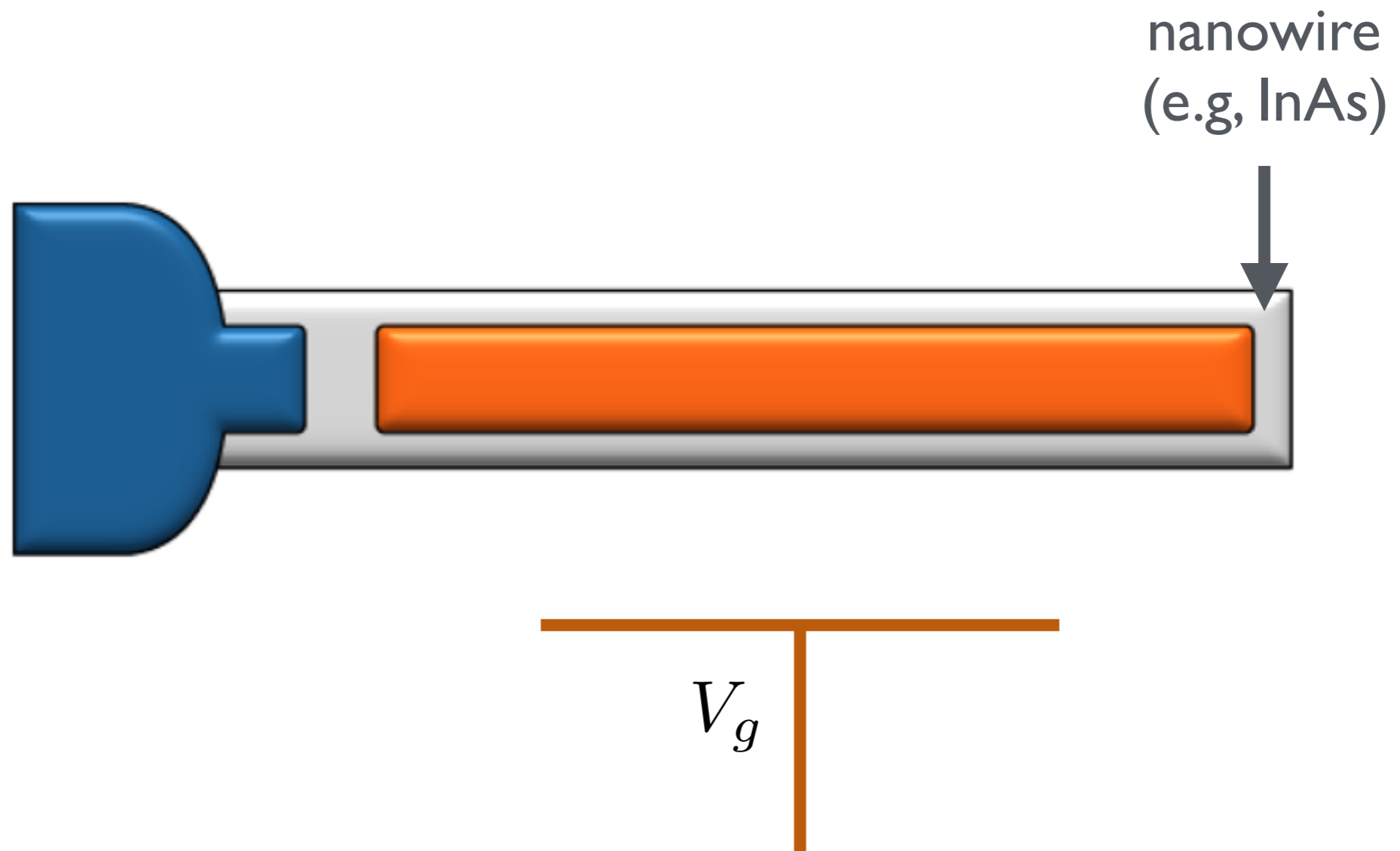

Majorana control scheme: setup

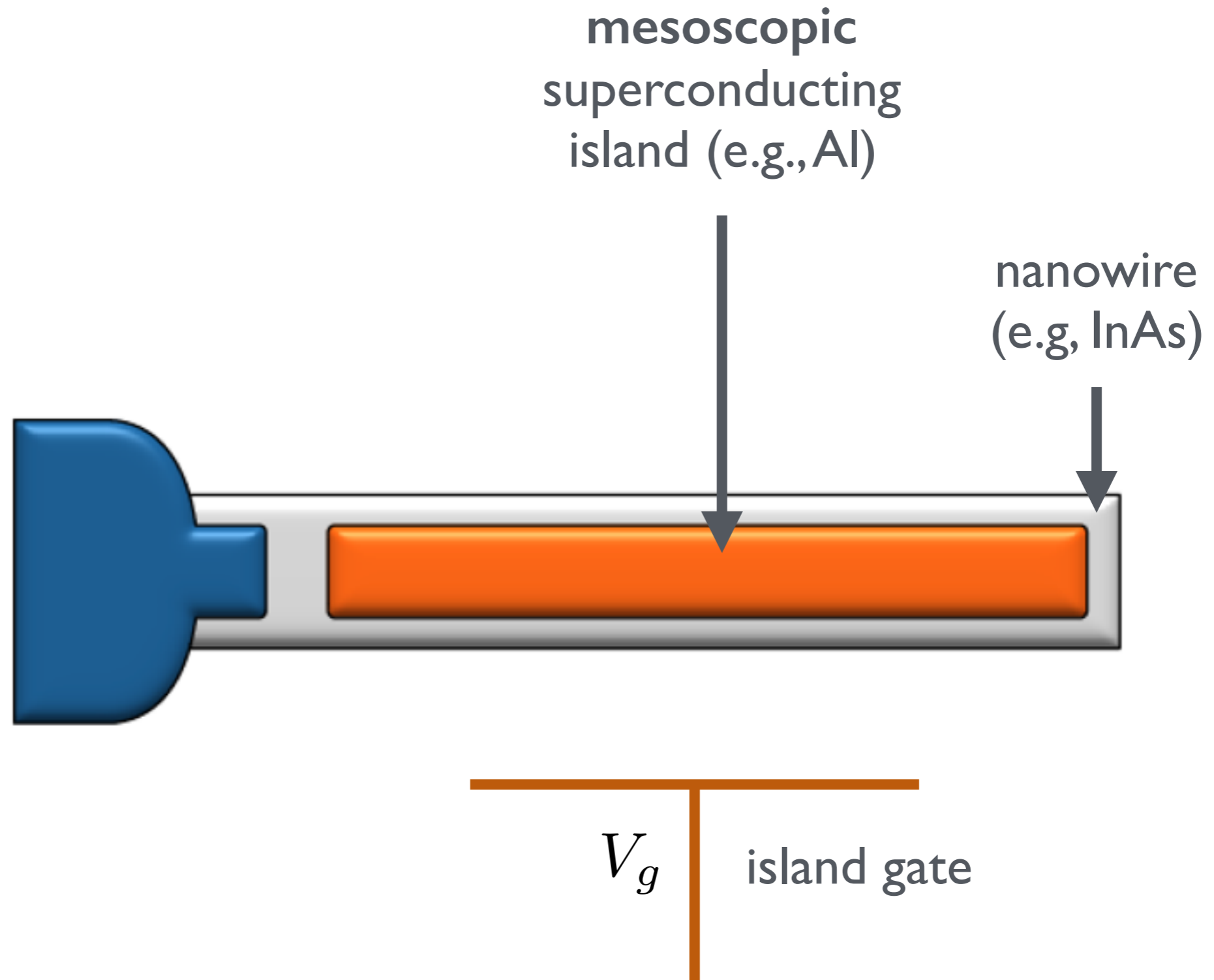

Majorana control scheme: setup

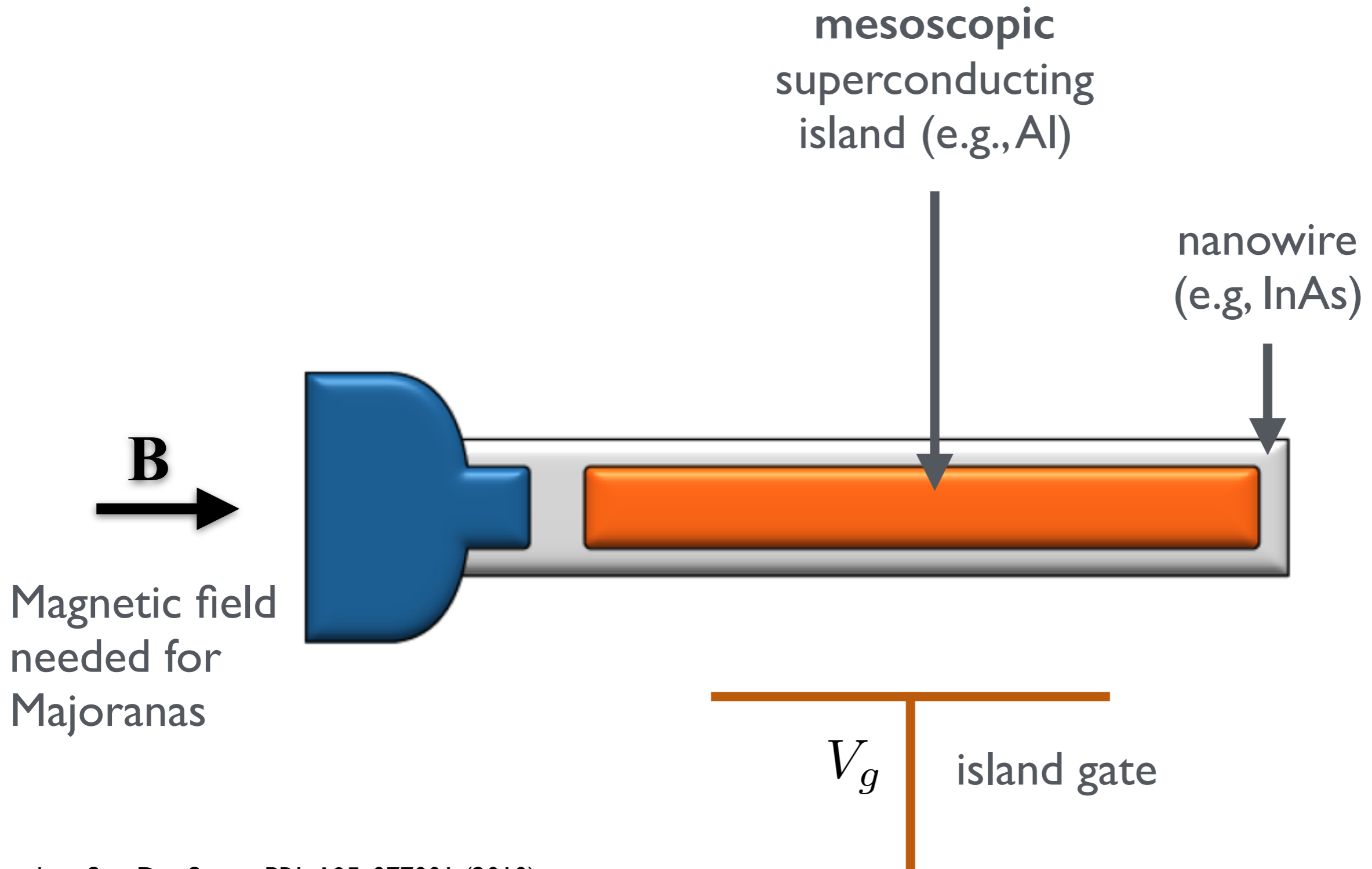

Majorana control scheme: setup

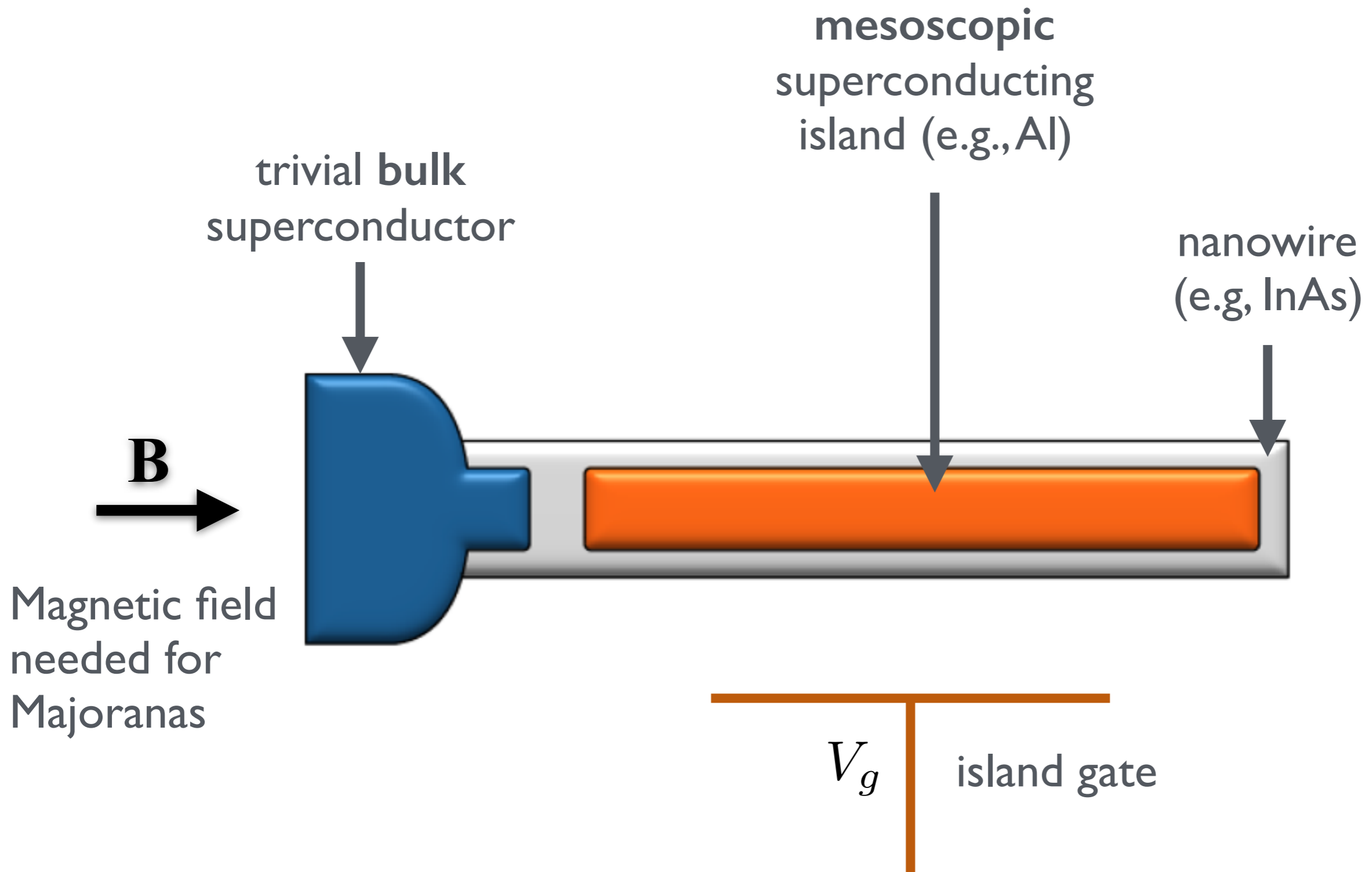

Majorana control scheme: setup

$$H = H_J[\hat{\phi}] + E_C(\hat{n} - n_{\text{offset}})^2$$

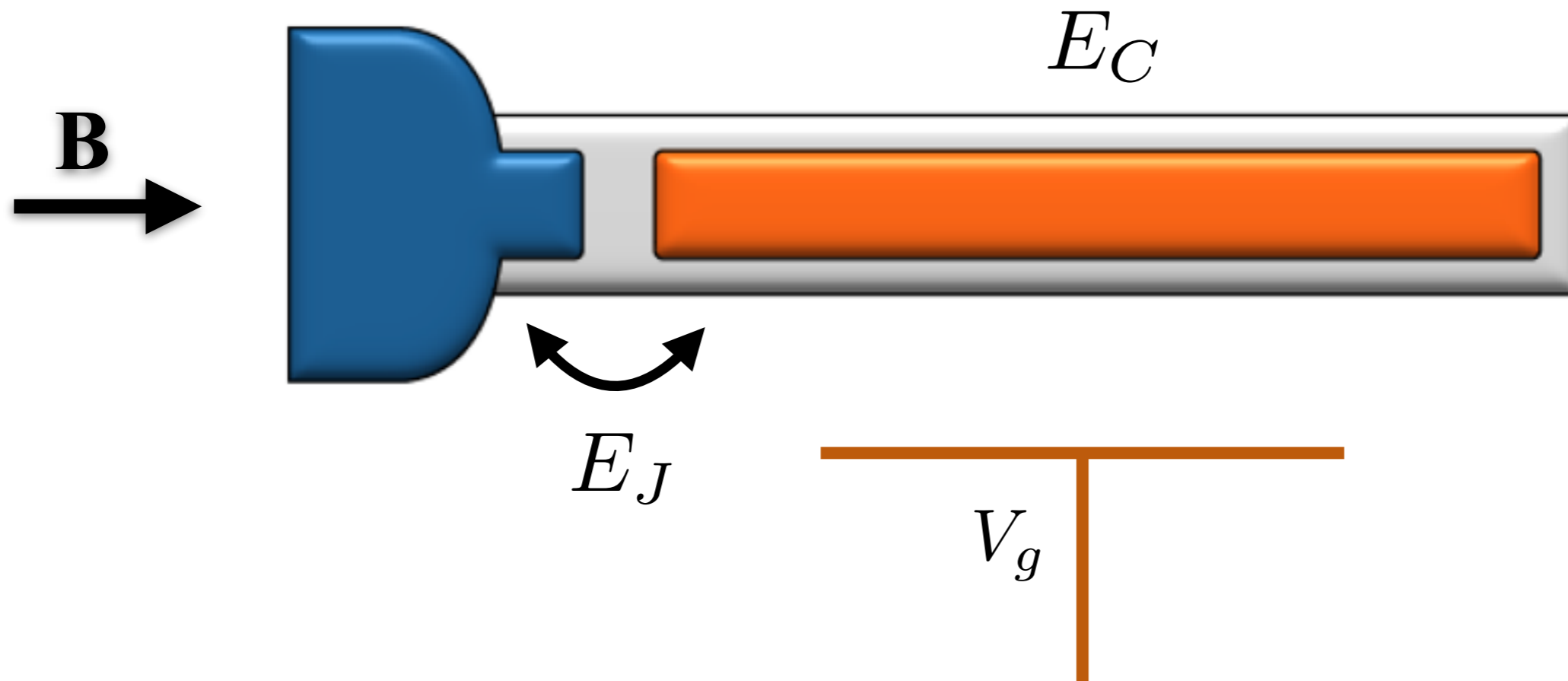

Majorana control scheme: setup

$$H = H_J[\hat{\phi}] + E_C(\hat{n} - n_{\text{offset}})^2$$

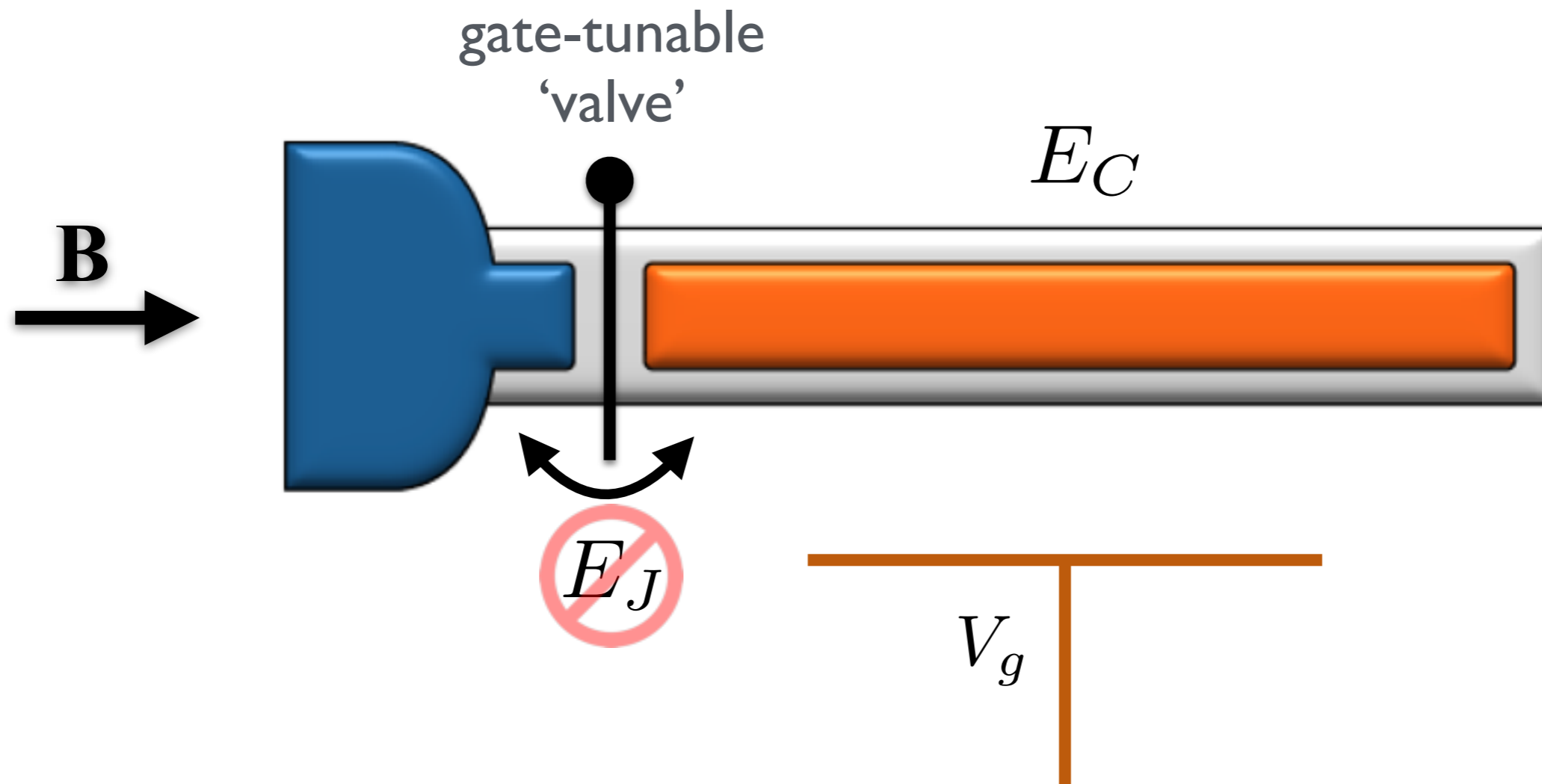

Majorana control scheme: setup

$$H = H_J[\hat{\phi}] + E_C(\hat{n} - n_{\text{offset}})^2$$

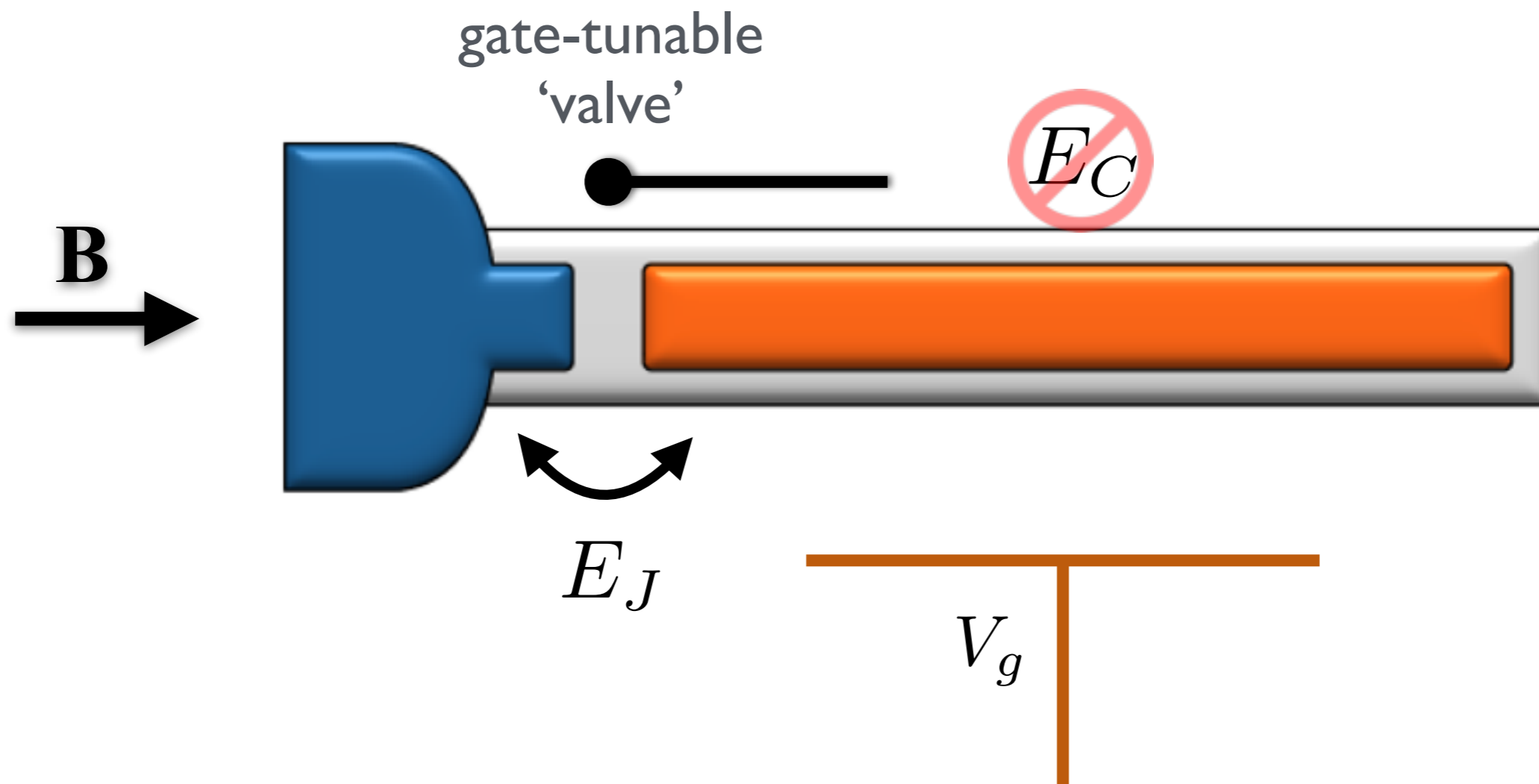

Majorana control scheme: setup

$$H = H_J[\hat{\phi}] + E_C(\hat{n} - n_{\text{offset}})^2$$

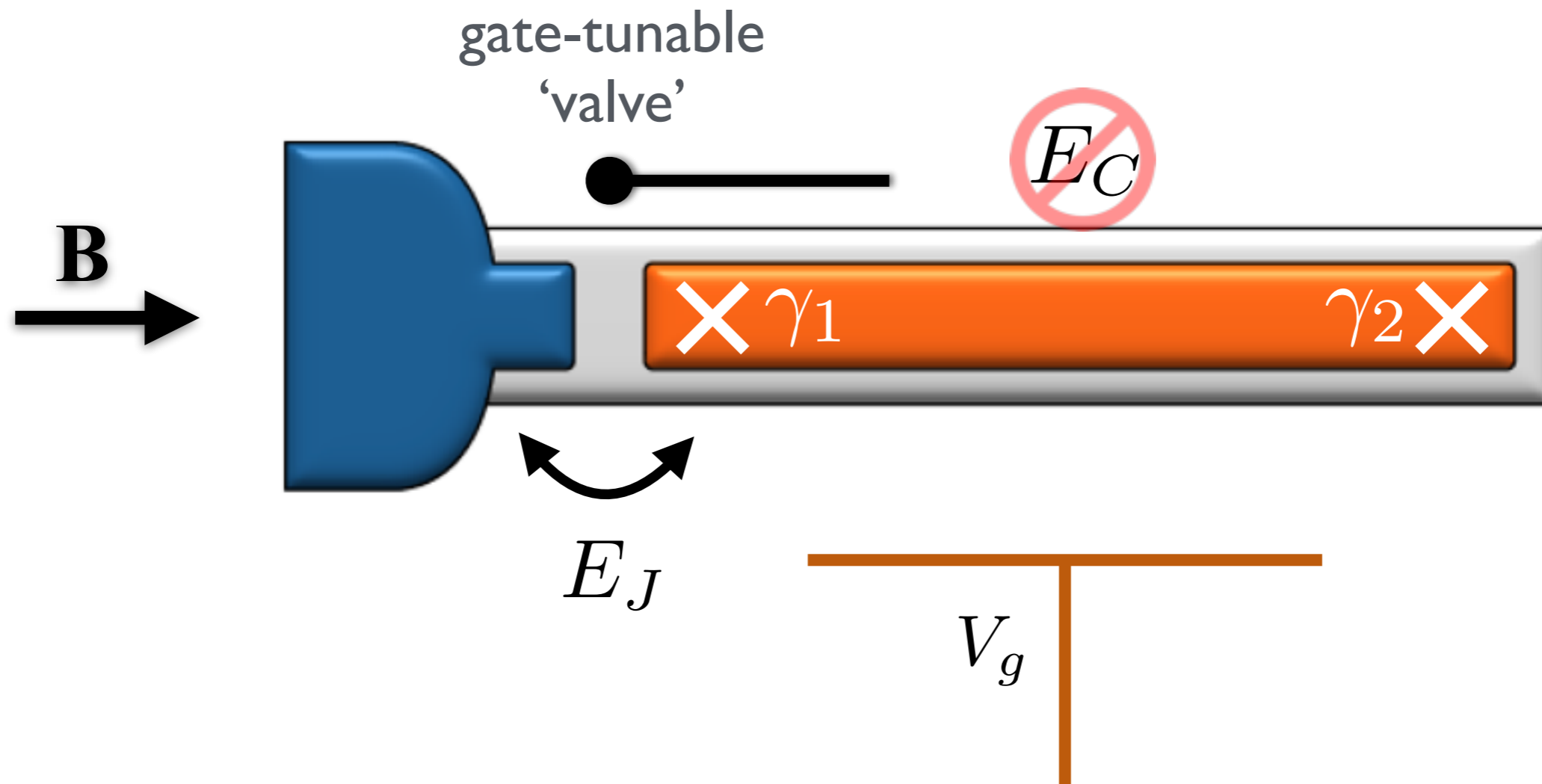

Parity-to-charge conversion

Initialization



Charge
eigenstates

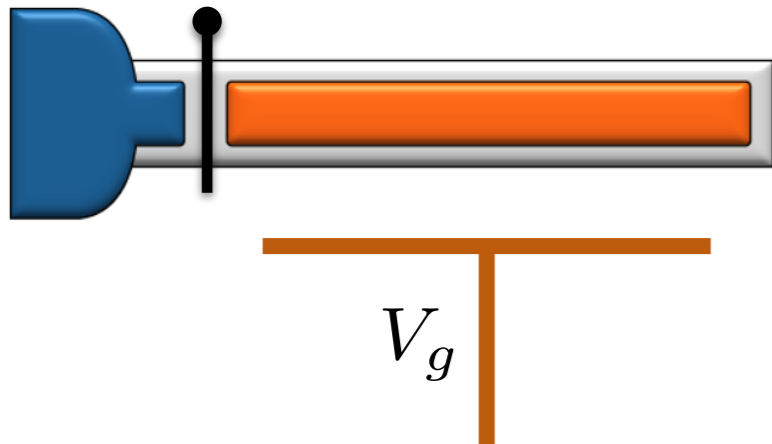

Parity
eigenstates

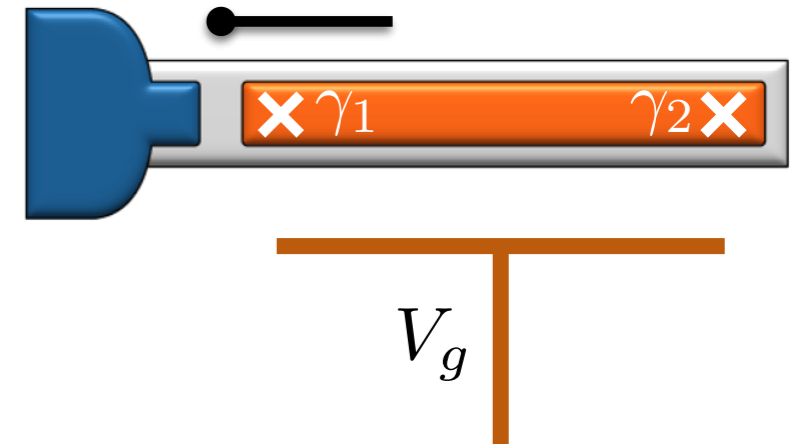

Readout



Multi-island extension

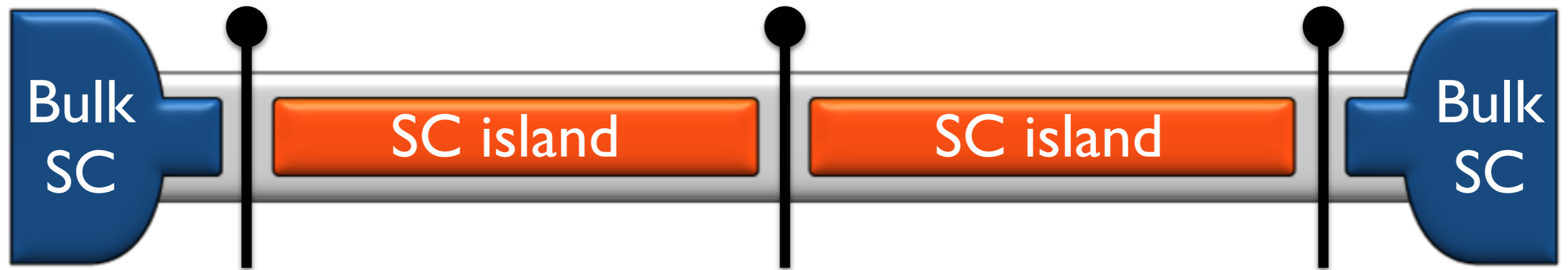

Double dot

Multi-island extension

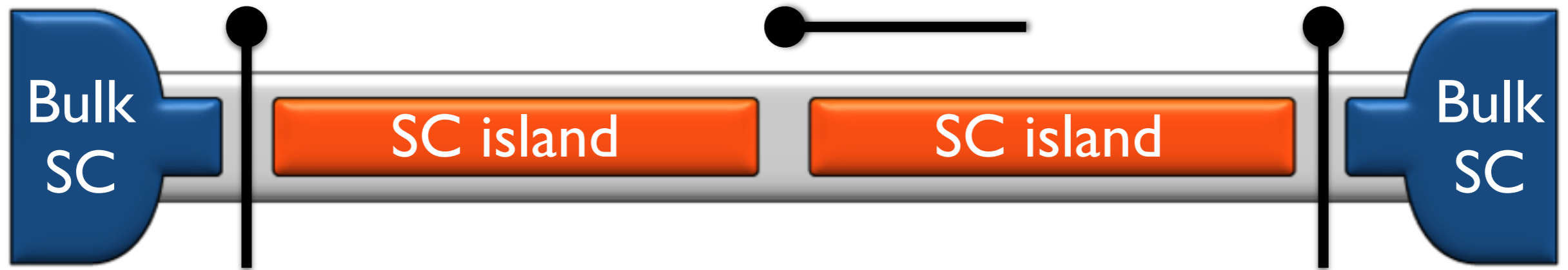

Double dot

Single dot

Multi-island extension

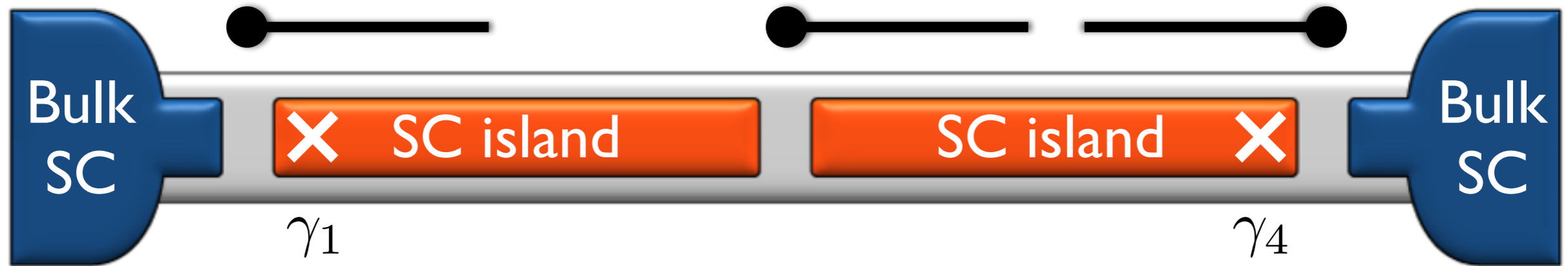

Double dot

Single dot

Topological superconductor

Multi-island extension

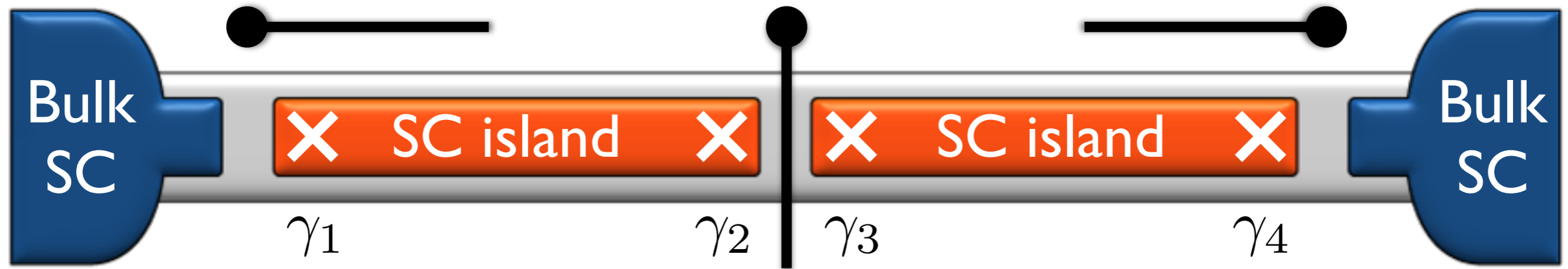

Double dot

Single dot

Topological superconductor

Double topological superconductor

Multi-island extension

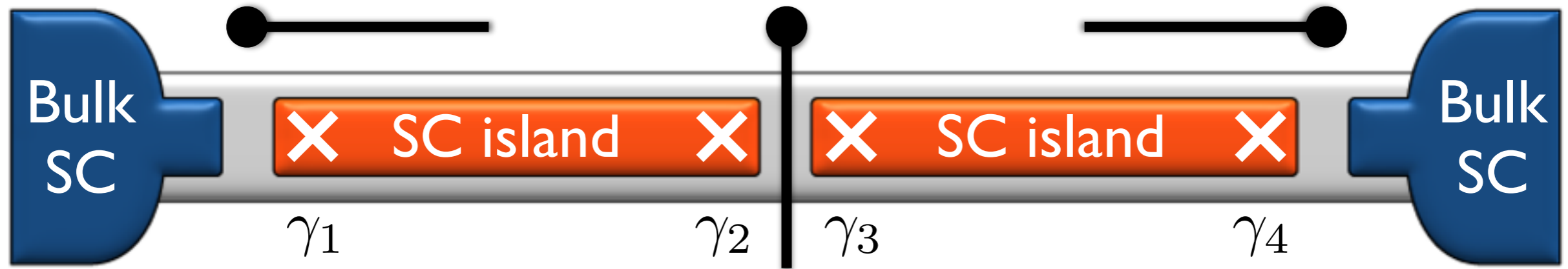

Double dot

Single dot

Topological superconductor

Double topological superconductor

Suffice for fusion rules,
topological qubit validation.

Multi-island extension

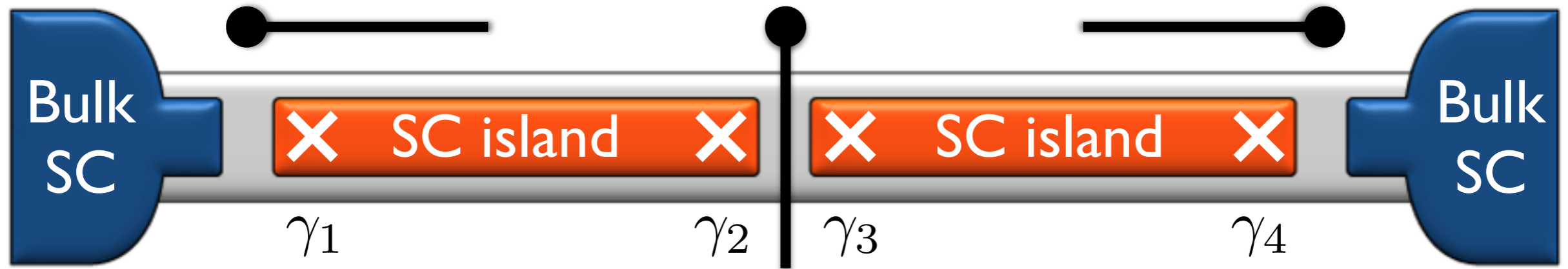

Double dot

Single dot

Topological superconductor

Double topological superconductor

Suffice for fusion rules,
topological qubit validation.

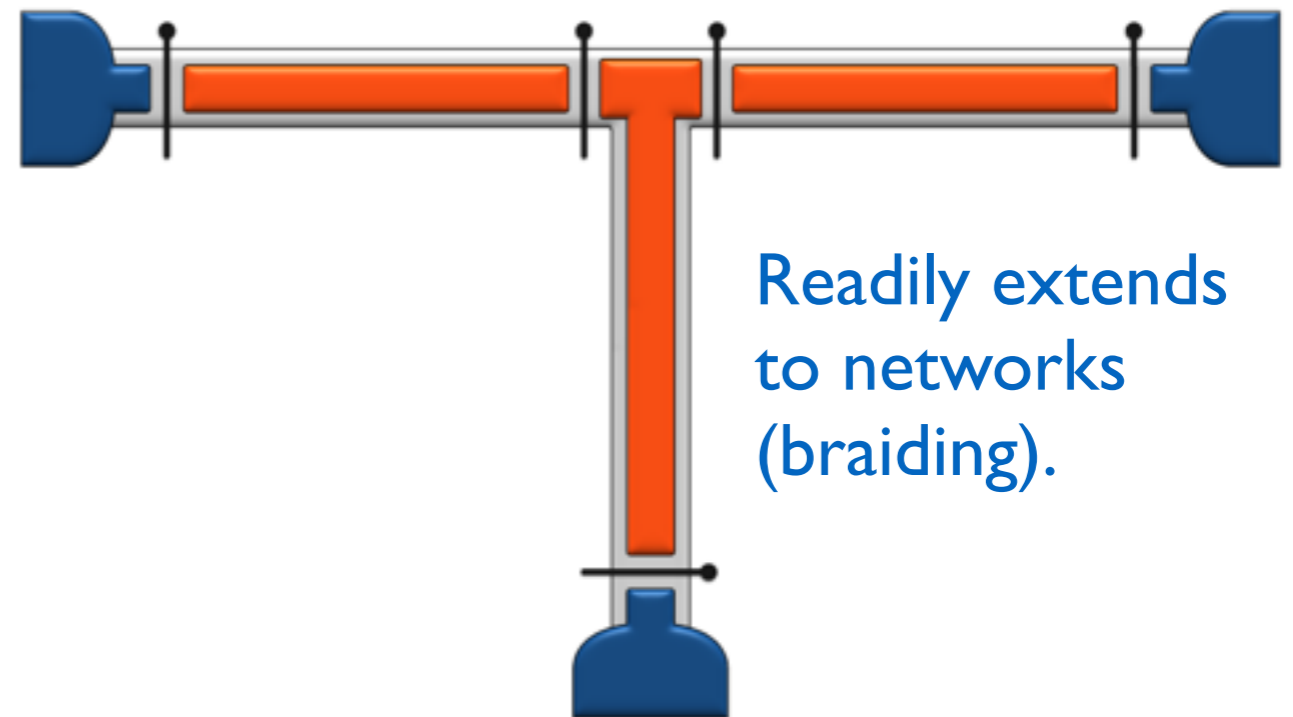

I. New all-electrical Majorana control scheme

II. Majorana-control milestones



Fusion-rule protocol

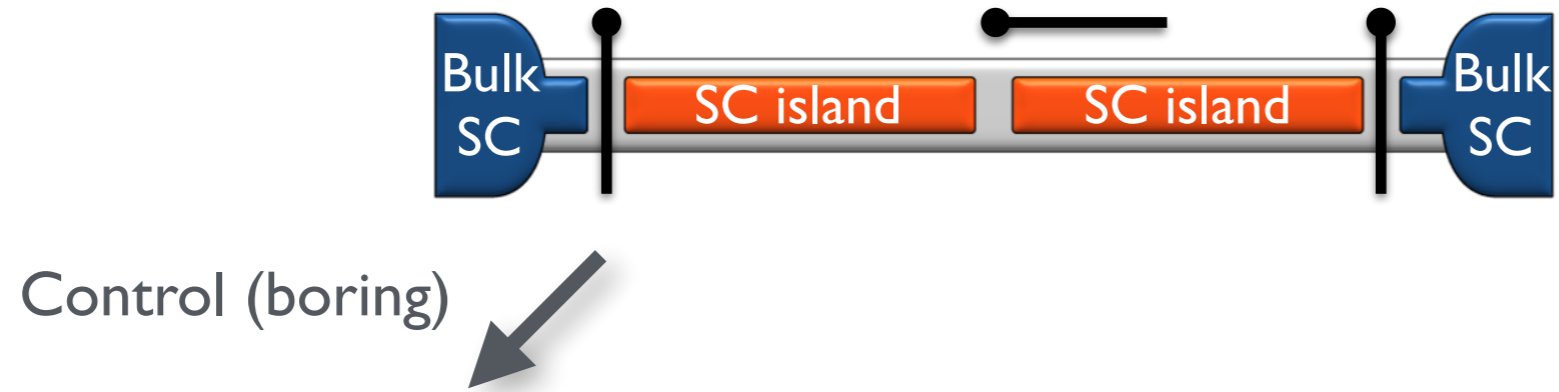

Fusion-rule protocol

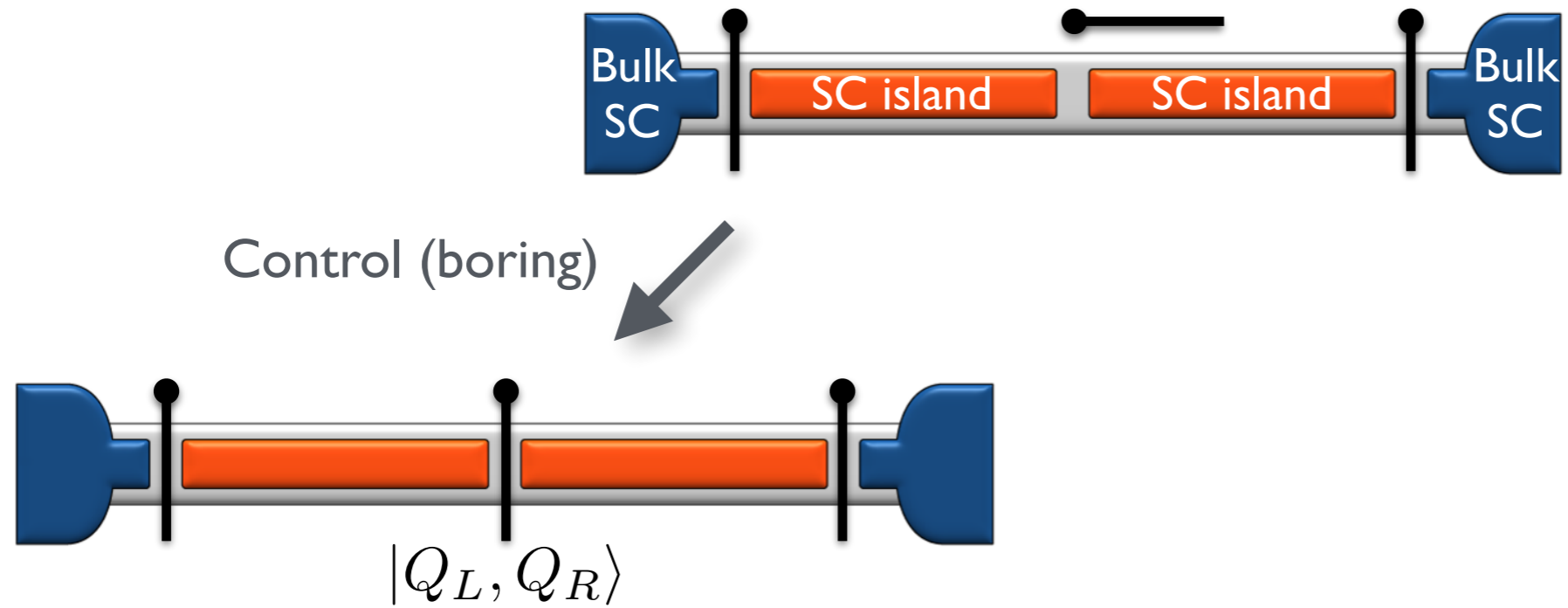

Fusion-rule protocol

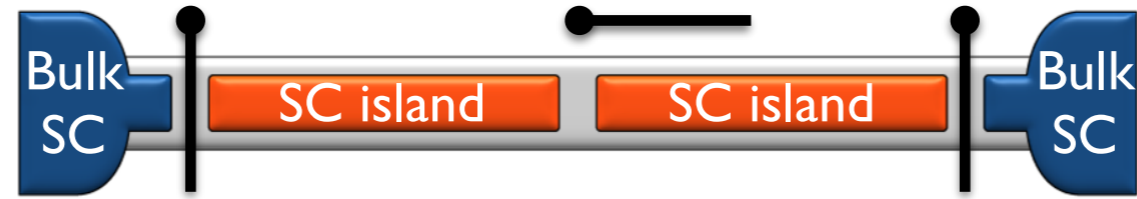

Control (boring)

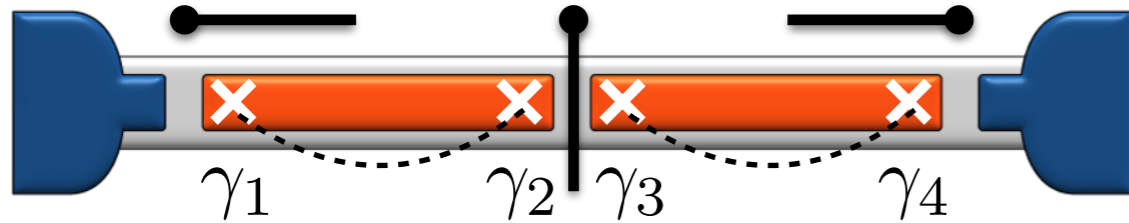
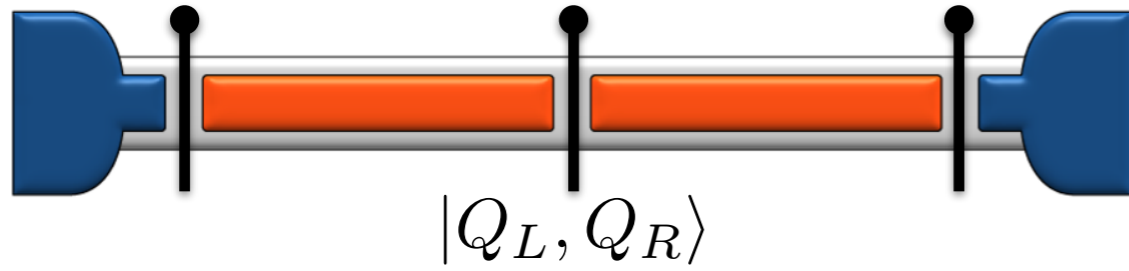

Fusion-rule protocol



Control (boring)

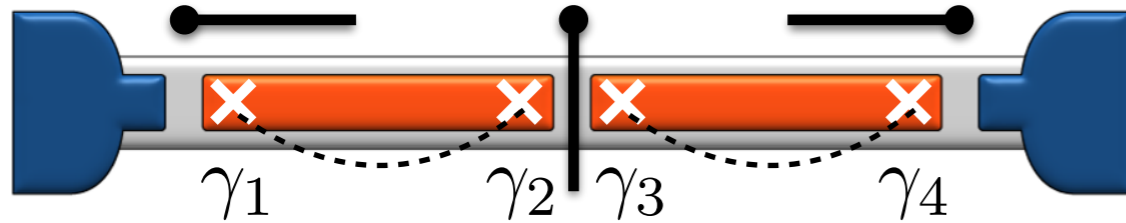
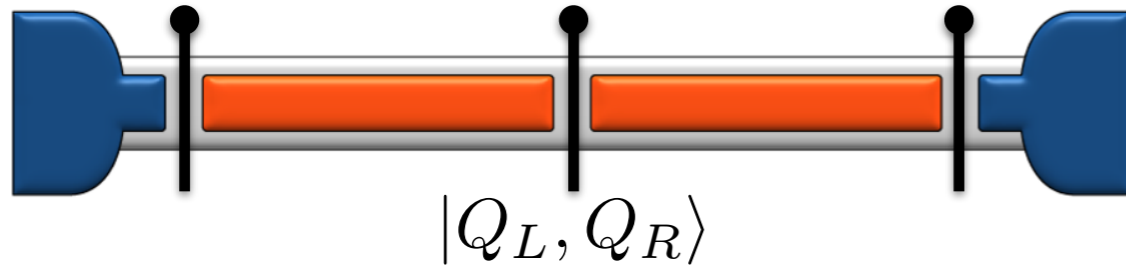

Fuse

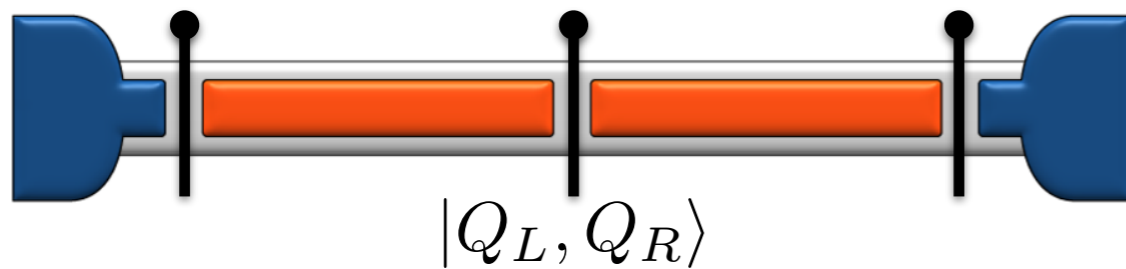

Deterministic charge measurement

$$\sigma \times \sigma = I + \cancel{\psi}$$

Fusion-rule protocol

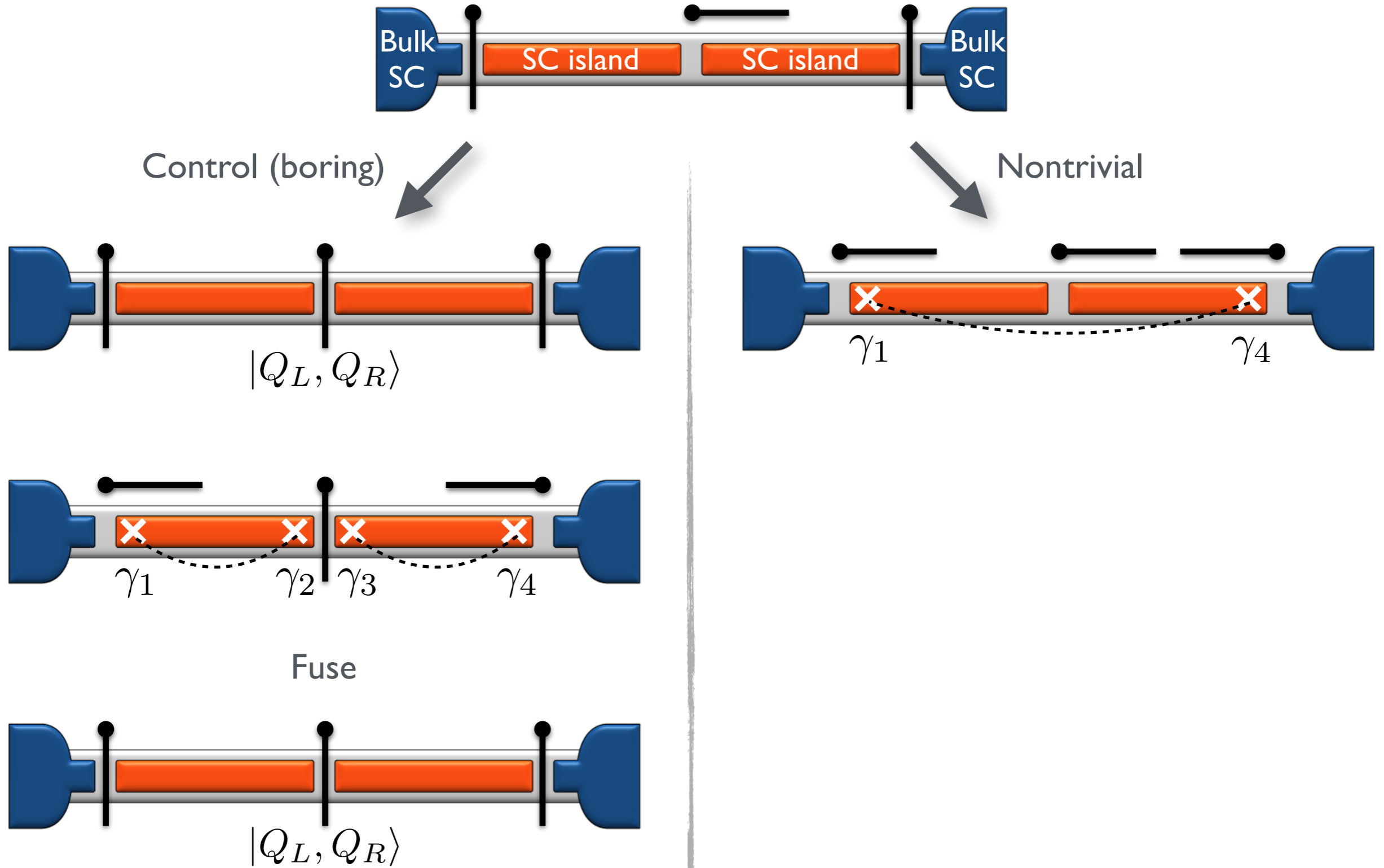

Deterministic charge measurement $\sigma \times \sigma = I + \cancel{\psi}$

Fusion-rule protocol

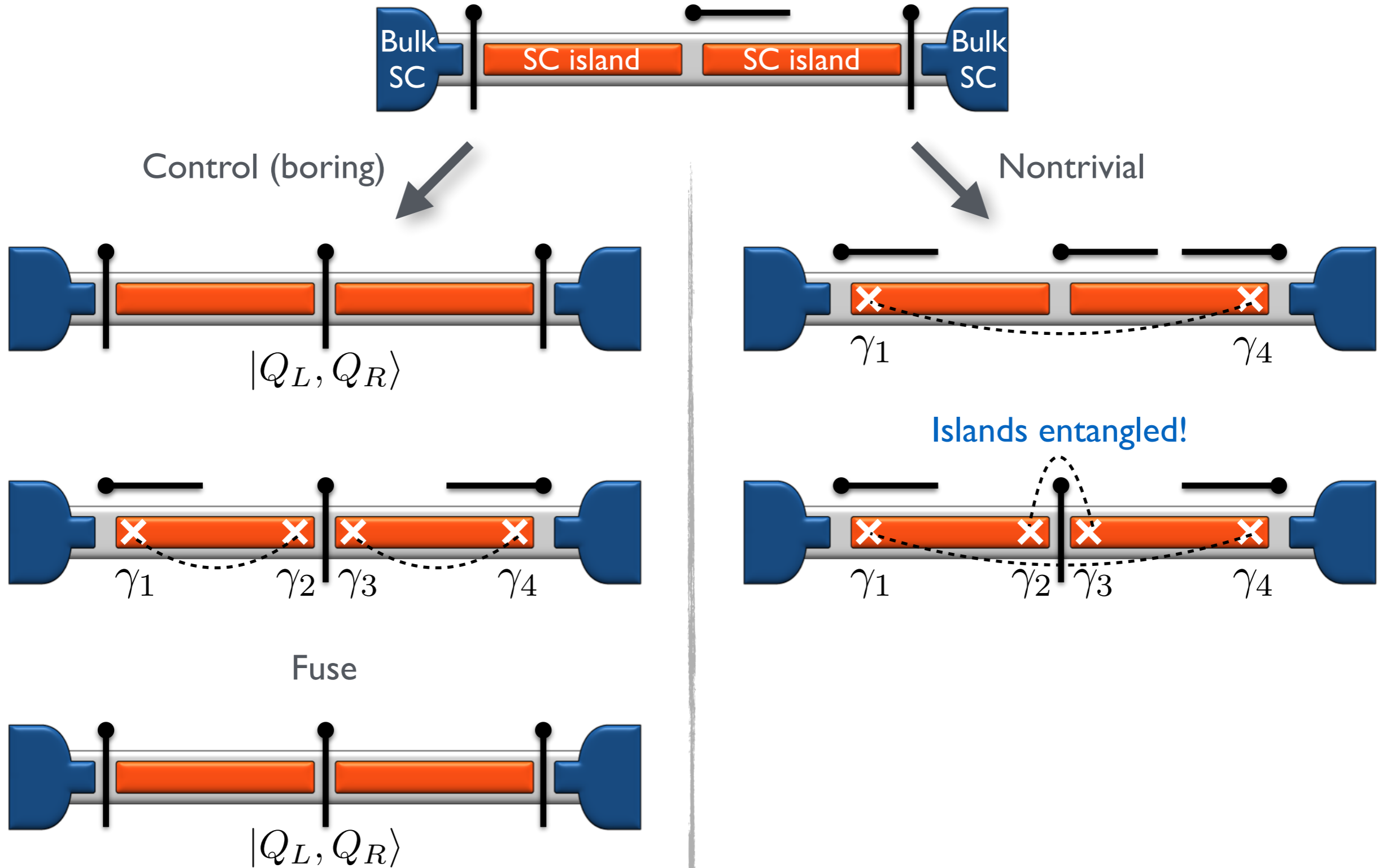

Deterministic charge measurement $\sigma \times \sigma = I + \psi$

Fusion-rule protocol

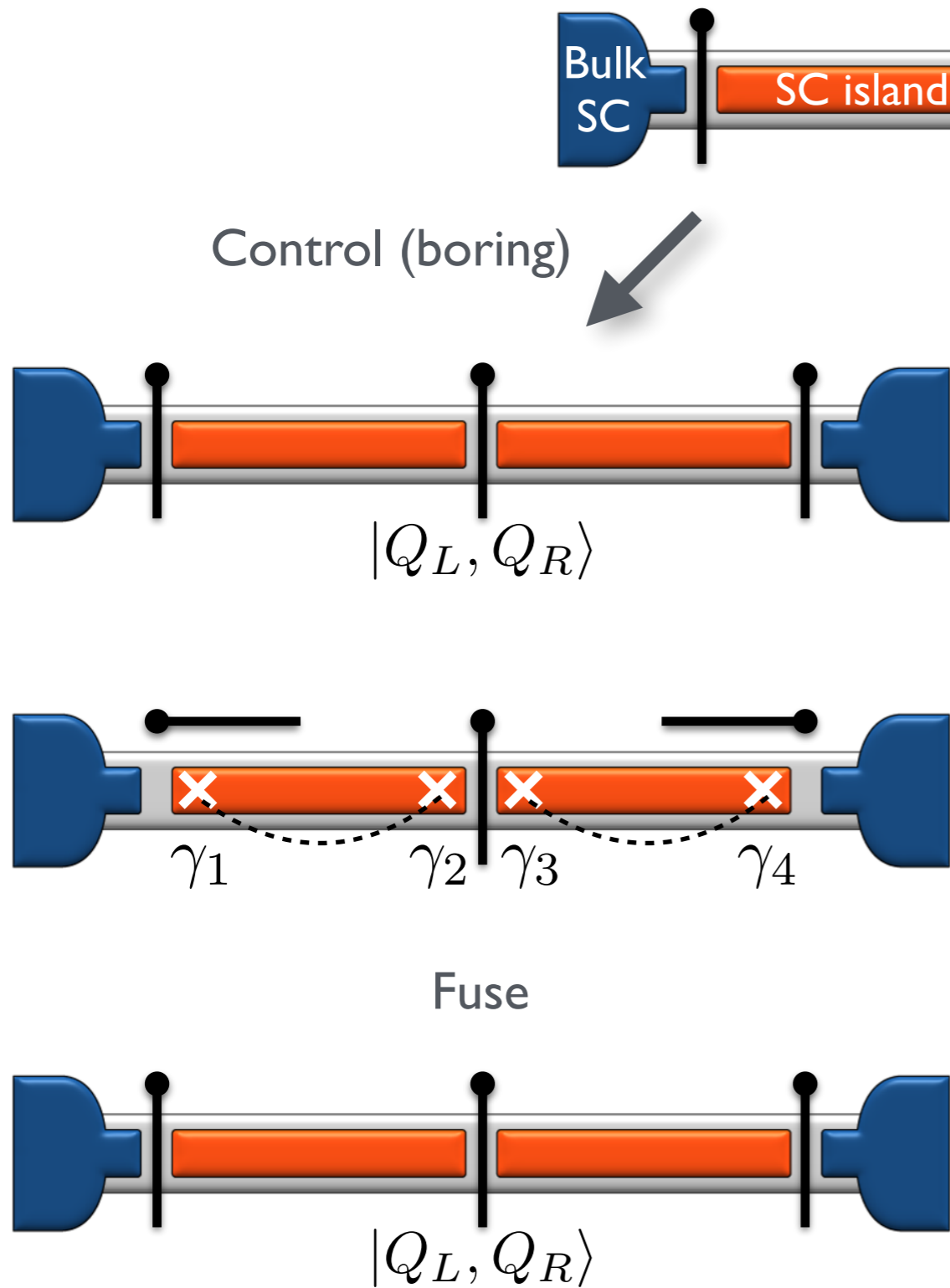

Deterministic charge measurement $\sigma \times \sigma = I + \psi$

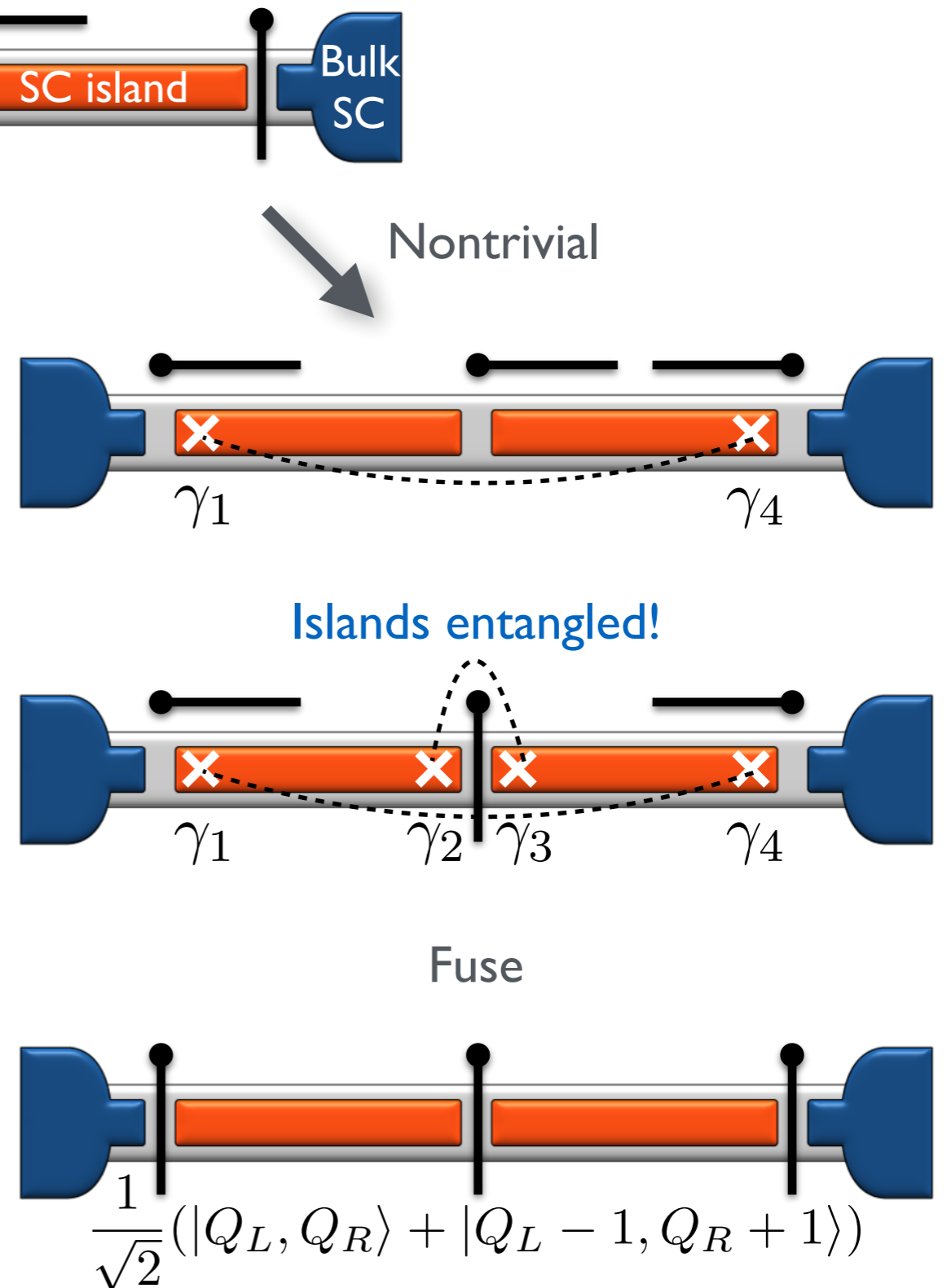

Probabilistic charge measurement! $\sigma \times \sigma = I + \psi$

Fusion-rule protocol

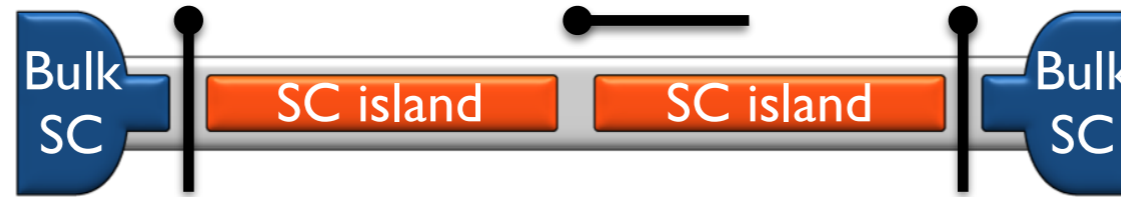

Control (boring)

Nontrivial

Comments

1. Experiment is “non-Abelian”
2. Control distinguishes from probabilistic outcome due to noise
3. Charge sensing unnecessary—can use “Majorana-mediated pump”!

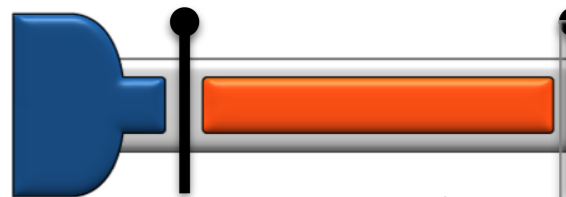

$|Q_L\rangle$

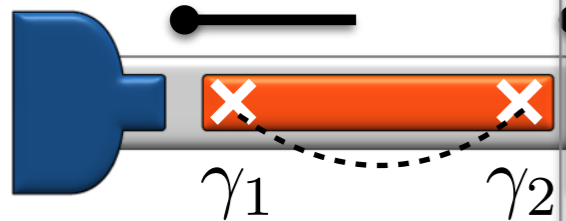

Fuse

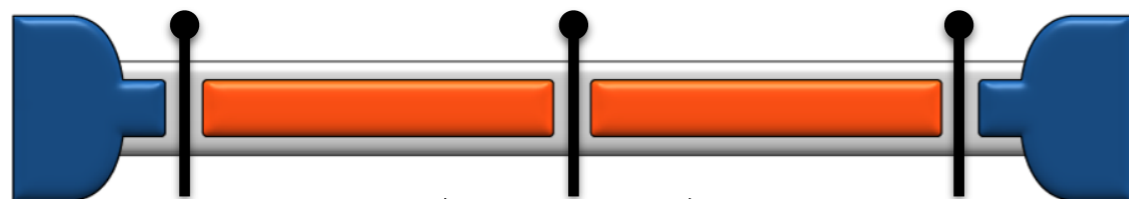

$|Q_L, Q_R\rangle$

Deterministic charge measurement

$$\sigma \times \sigma = I + \cancel{\psi}$$



entangled!

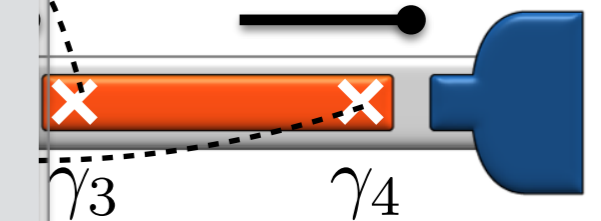

Fuse

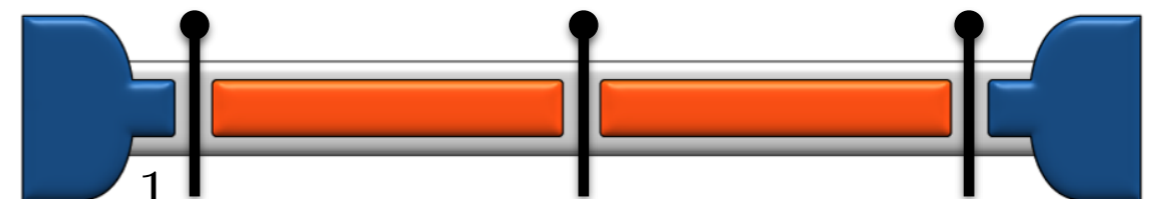

$$\frac{1}{\sqrt{2}}(|Q_L, Q_R\rangle + |Q_L - 1, Q_R + 1\rangle)$$

Probabilistic charge measurement!

$$\sigma \times \sigma = I + \psi$$

I. New all-electrical Majorana control scheme

II. Majorana-control milestones

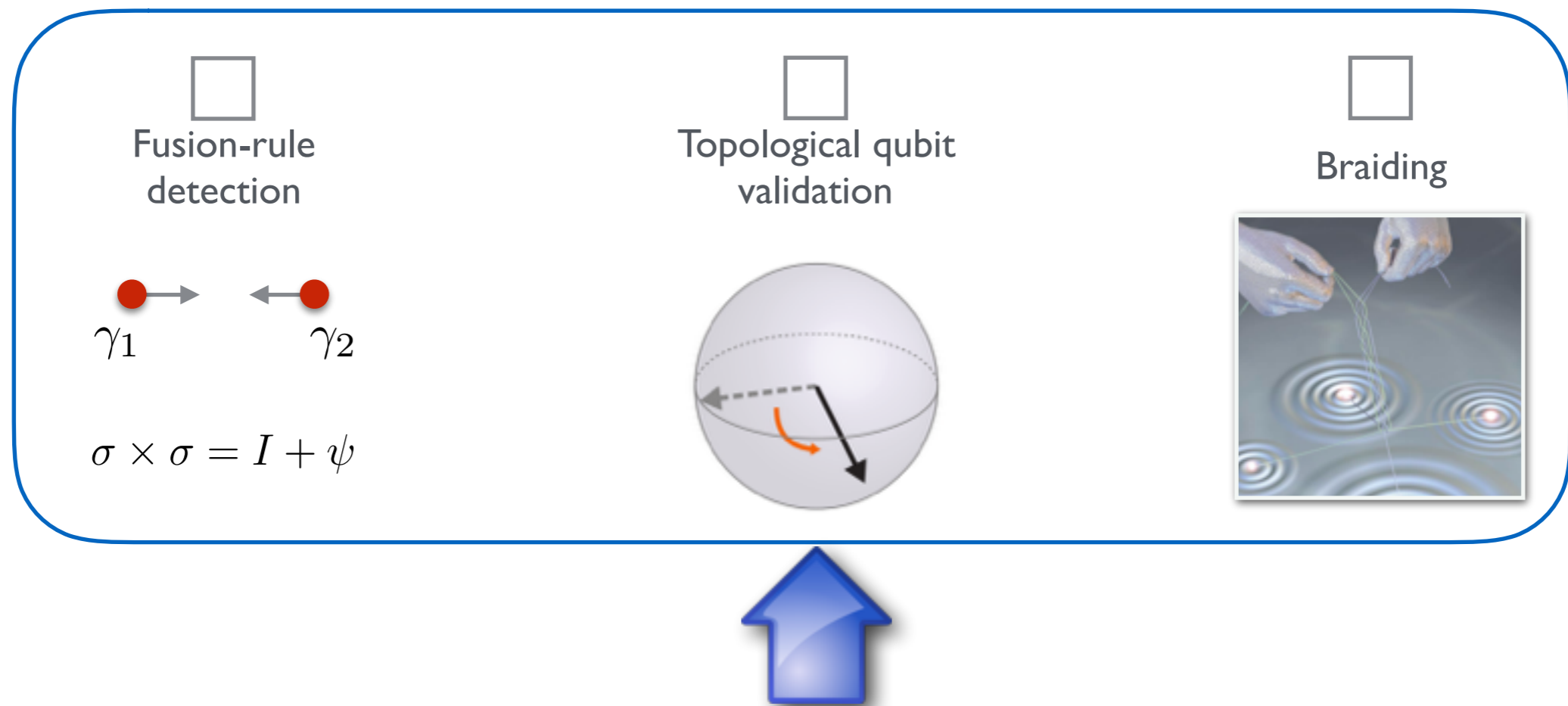

Prototype topological qubit

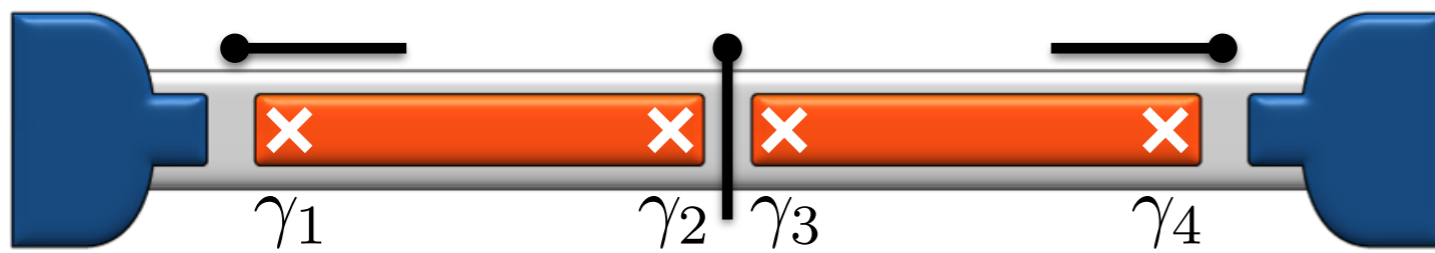

Excited states

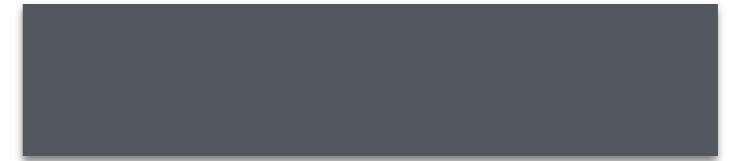

Locally indistinguishable ground states

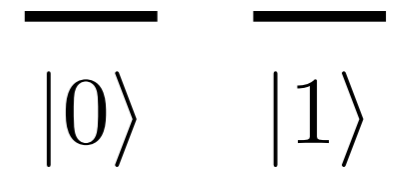

Gap



Prototype topological qubit

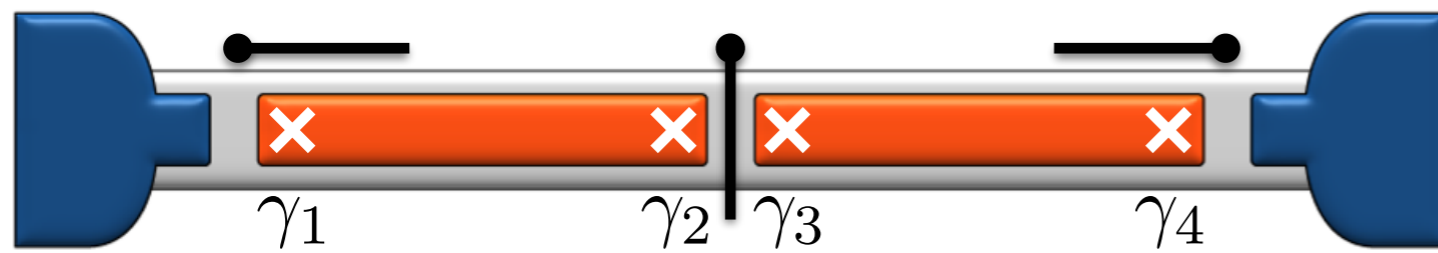

Excited states

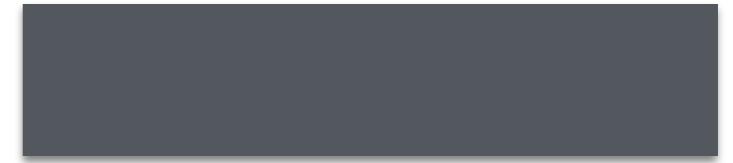

Locally indistinguishable ground states

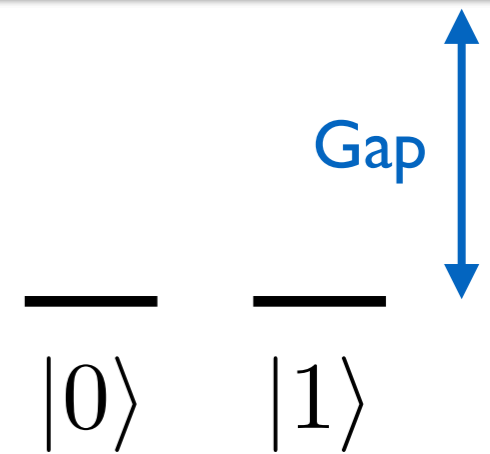

Topological protection requires

1. Time scales \ll poisoning time
2. System confined to ground states w/high probability (i.e., low T , low frequency noise)

Prototype topological qubit

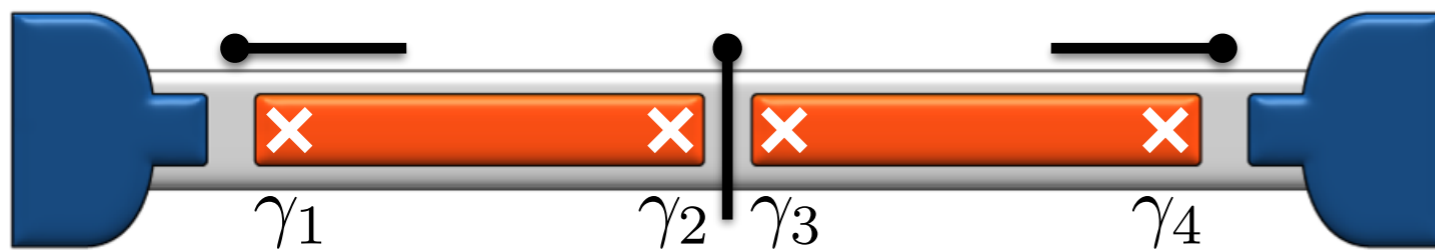

Excited states

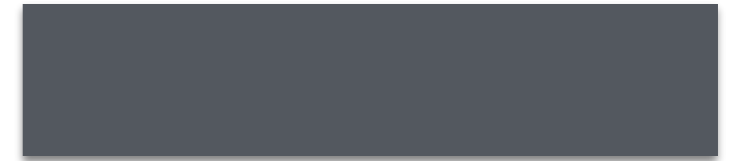

Locally indistinguishable ground states

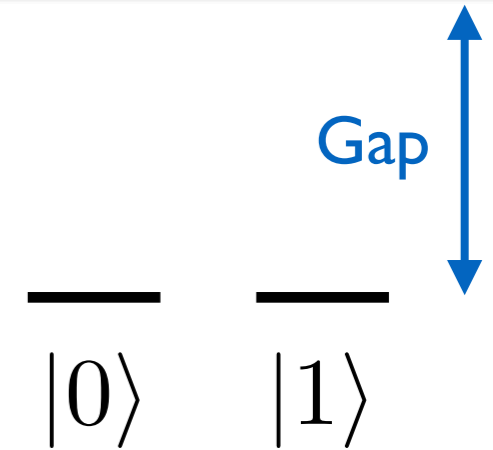

Topological protection requires

1. Time scales \ll poisoning time
2. System confined to ground states w/high probability (i.e., low T, low frequency noise)



Fundamental question:
Assuming these hold, how to verify topological protection in above device??

Prototype topological qubit

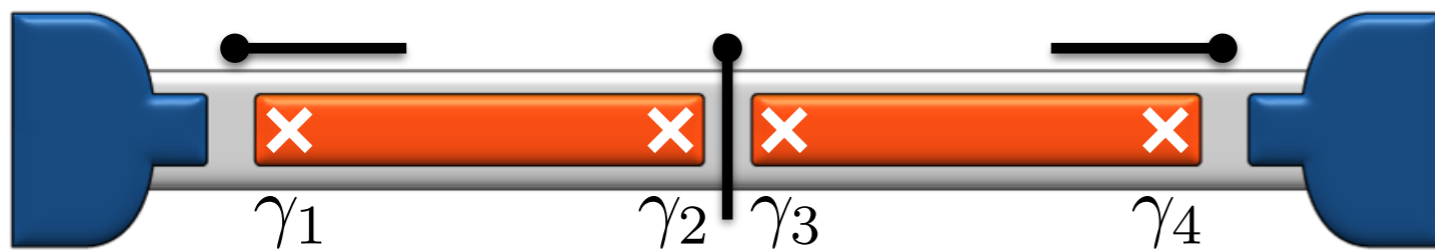

Excited states

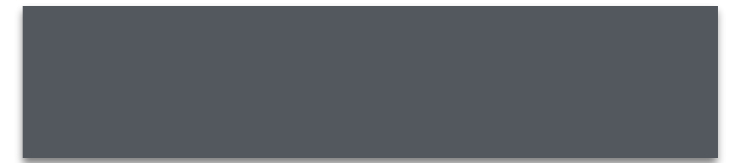

Locally indistinguishable ground states

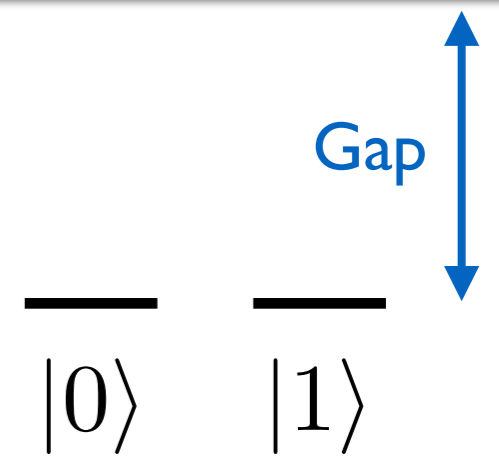

Topological protection requires

1. Time scales \ll poisoning time
2. System confined to ground states w/high probability (i.e., low T , low frequency noise)



Fundamental question:
Assuming these hold, how to verify topological protection in above device??

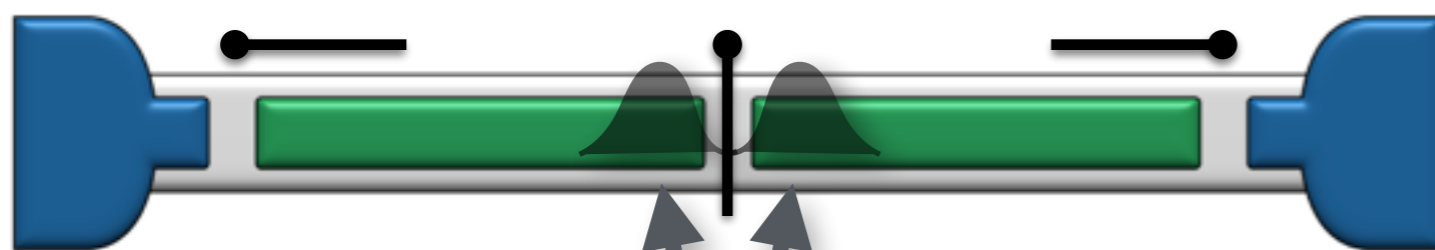

Conventional zero-energy bound states

Excited states



“Accidental” degeneracies

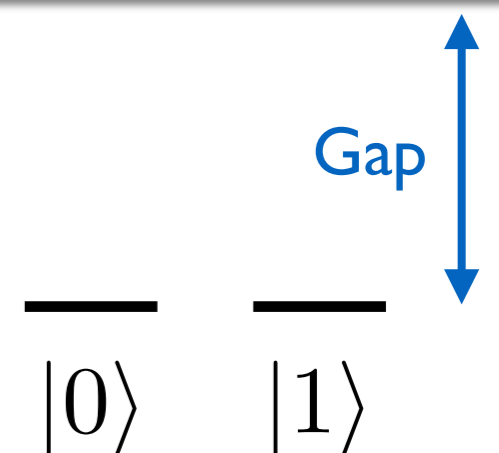

Prototype topological qubit

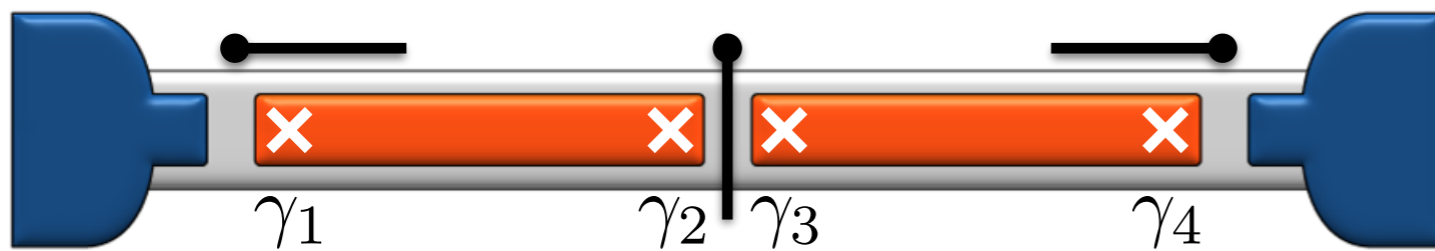

Excited states

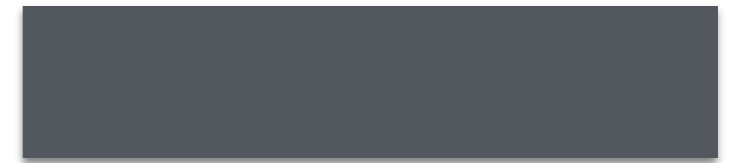

Locally indistinguishable ground states

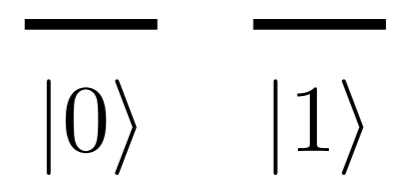

Answer must sharply distinguish these qubits!

Fundamental question:
Assuming these hold, how to verify topological protection in above device??

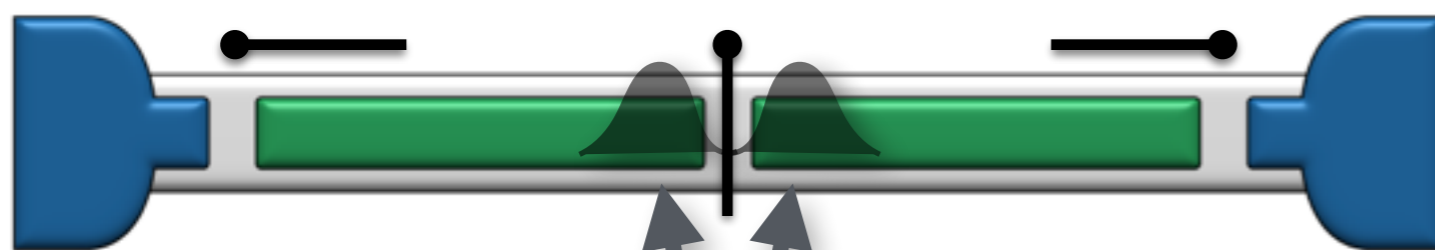

Conventional zero-energy bound states

Excited states



“Accidental” degeneracies



Prototype topological qubit

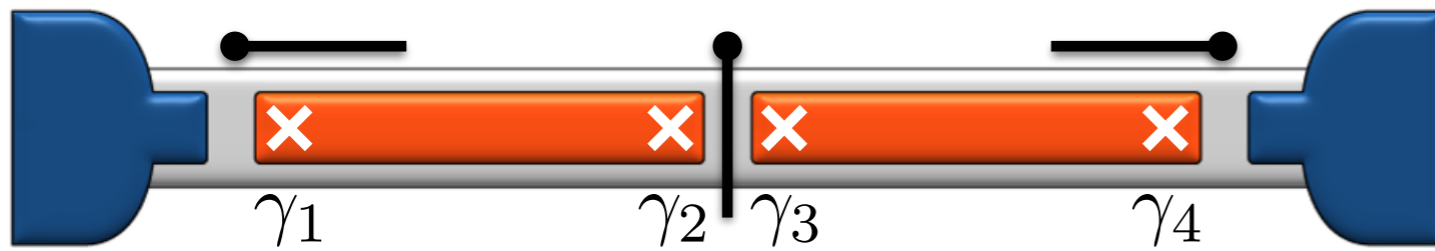

Answer must sharply distinguish these qubits!

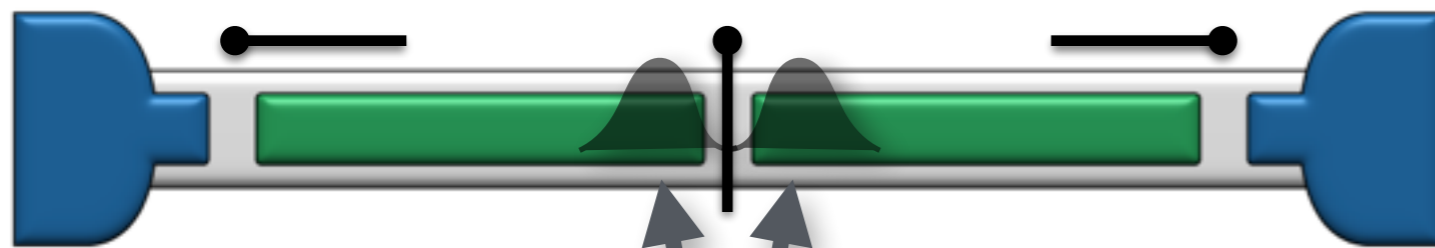

Conventional zero-energy bound states

Excited states

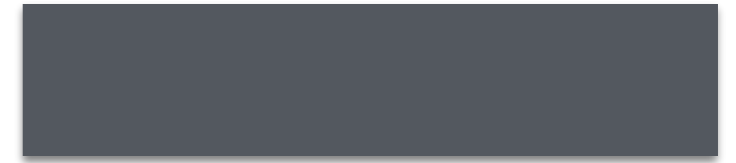

Locally indistinguishable ground states

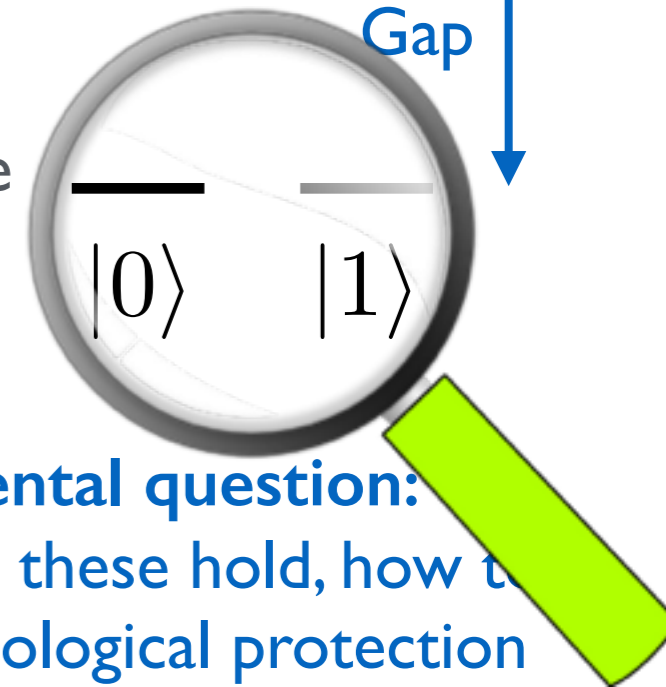

Fundamental question:
Assuming these hold, how to verify topological protection in above device??

Excited states

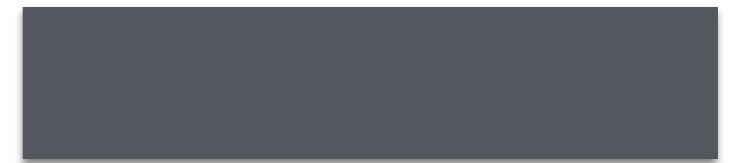

“Accidental” degeneracies



Peculiar noise sensitivity

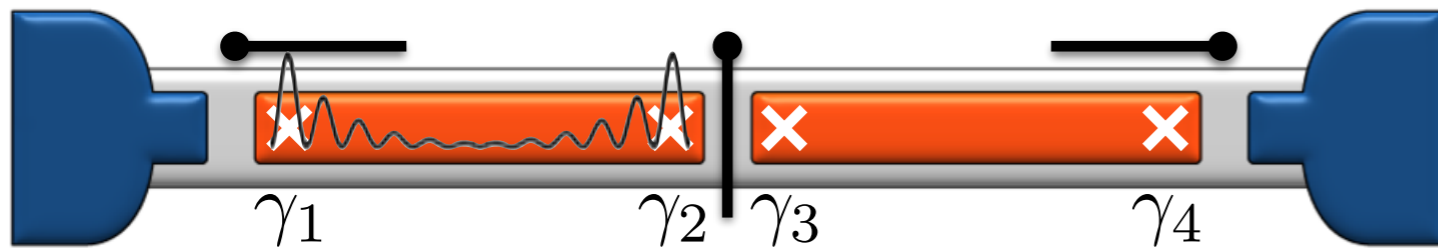

$$\omega_0 \propto \cos(\kappa L) e^{-L/\xi}$$

$$|1\rangle \begin{array}{c} \downarrow \\ \hline \end{array}$$
$$|0\rangle \begin{array}{c} \hline \uparrow \end{array}$$

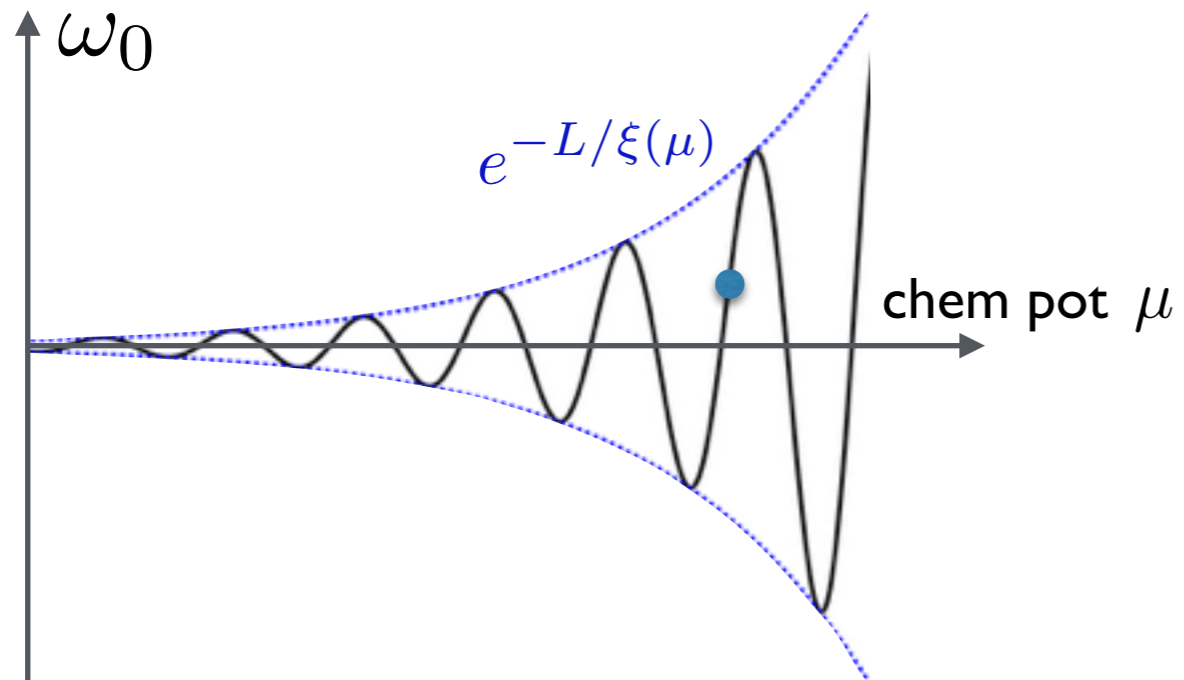

Peculiar noise sensitivity

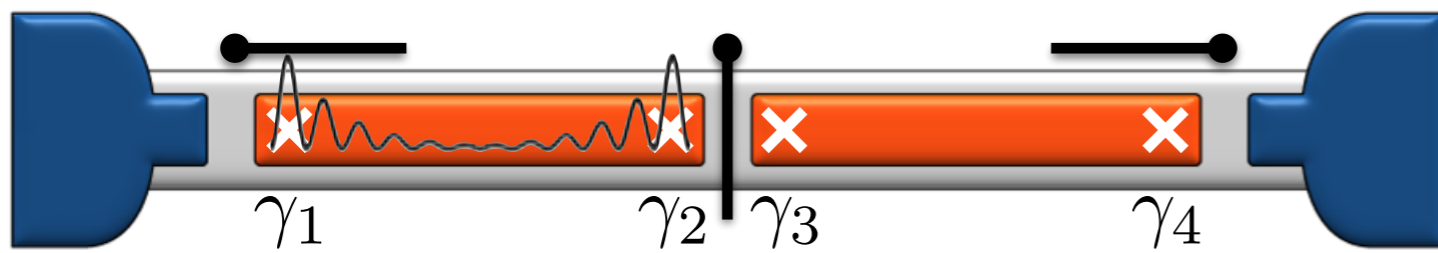

$$\omega_0 \propto \cos(\kappa L) e^{-L/\xi}$$

$$|1\rangle \begin{array}{c} \downarrow \\ \hline \end{array}$$
$$|0\rangle \begin{array}{c} \hline \uparrow \end{array}$$

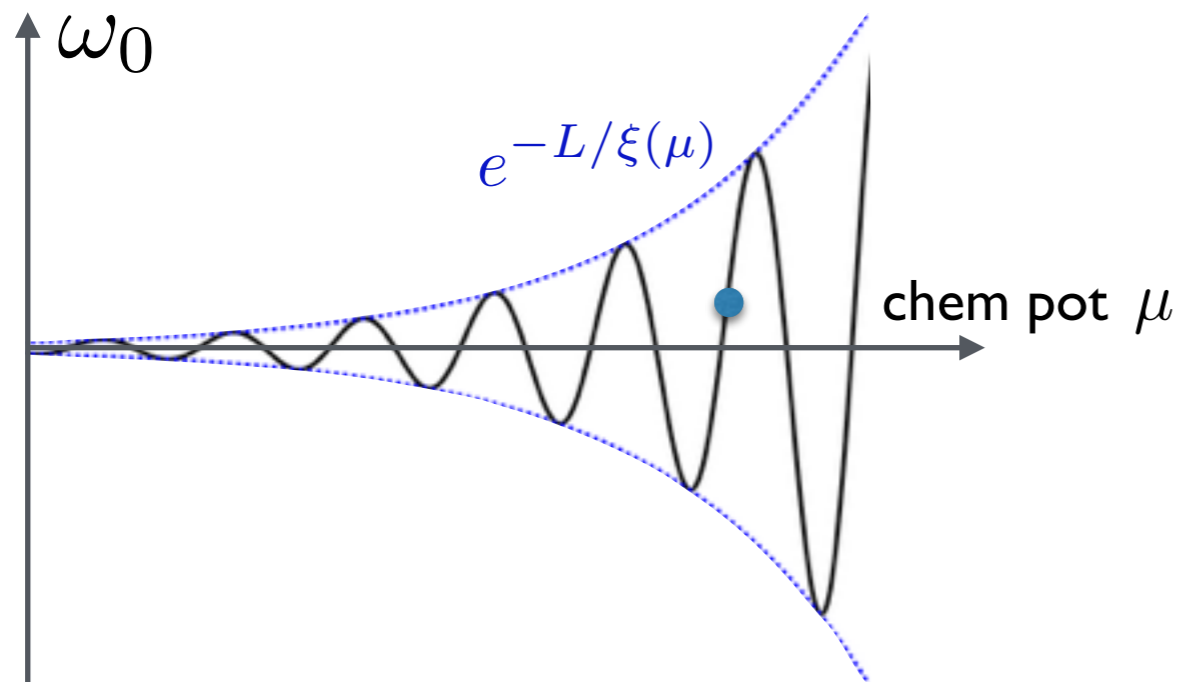

Peculiar noise sensitivity

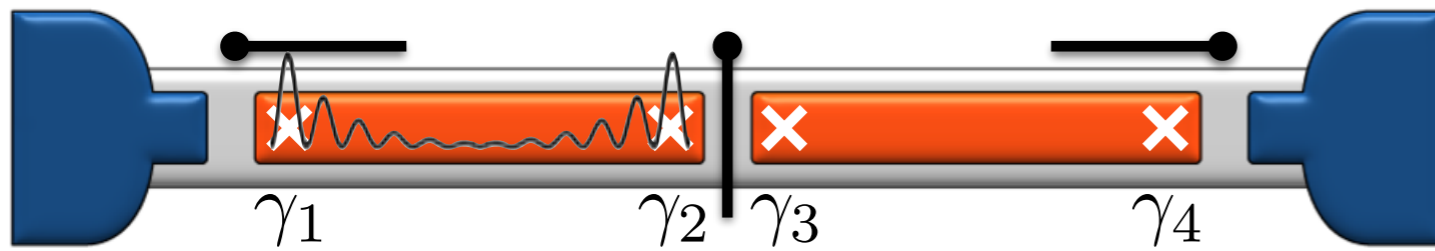

$$\omega_0 \propto \cos(\kappa L) e^{-L/\xi}$$

$$\begin{array}{l} |1\rangle \downarrow \\ |0\rangle \uparrow \end{array}$$

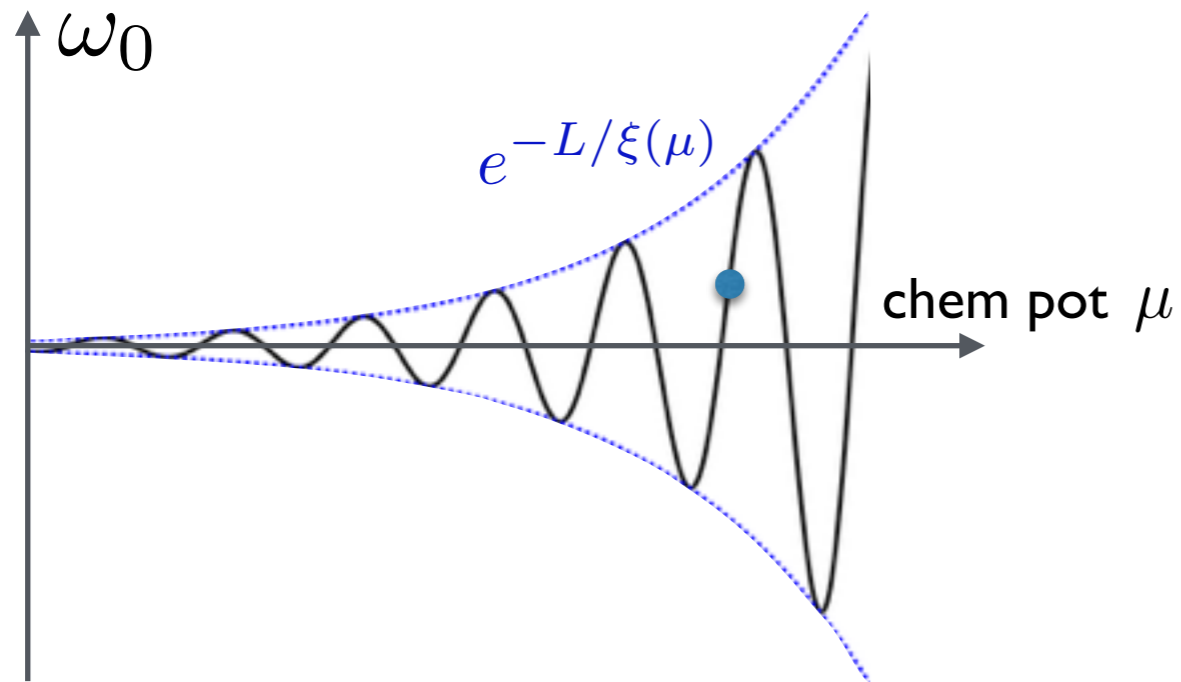

Time-averaged quantities & fluctuations deeply linked for topological qubit!

Peculiar noise sensitivity

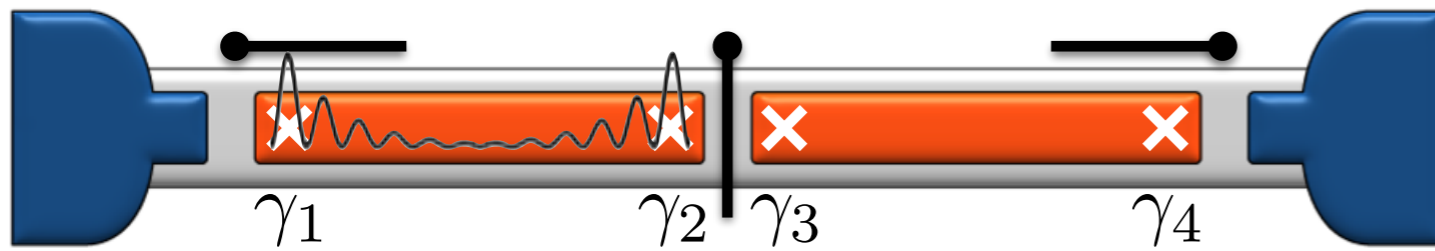

$$\omega_0 \propto \cos(\kappa L) e^{-L/\xi}$$

$$|1\rangle \begin{array}{c} \downarrow \\ \hline \end{array}$$

$$|0\rangle \begin{array}{c} \hline \uparrow \end{array}$$

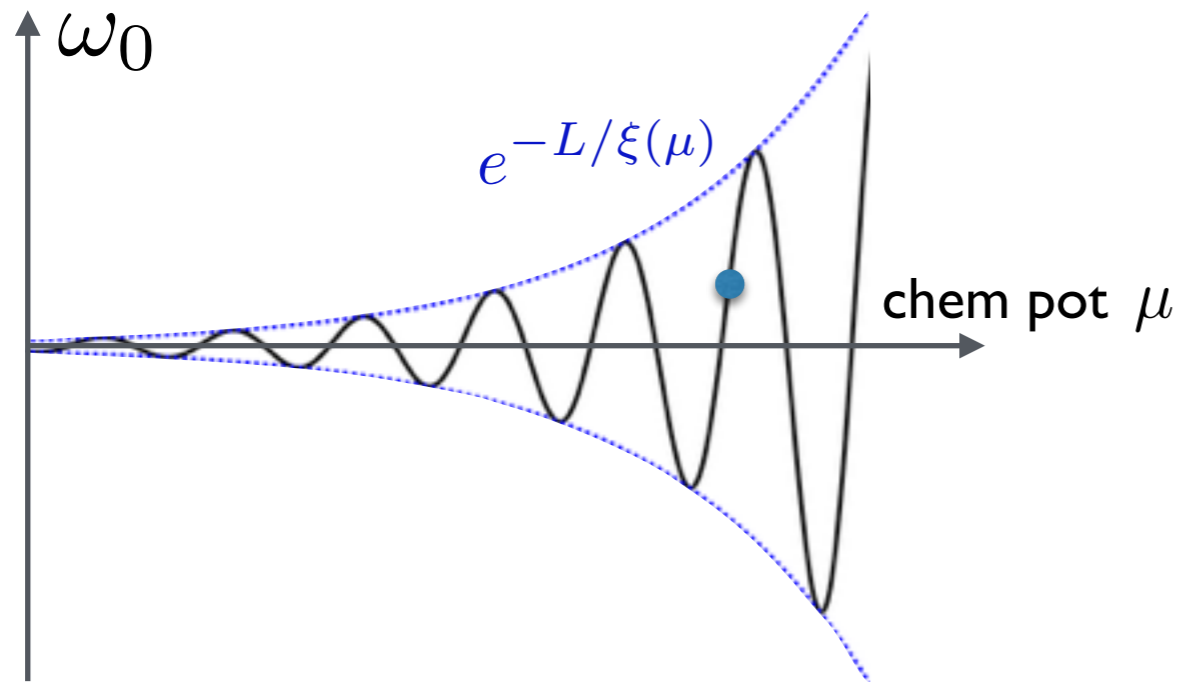

$$\omega_0 \sim \Delta E_{\text{typical}}$$

$$T_2 \sim \hbar / \Delta E_{\text{typical}}$$



$$1/T_2 \sim \omega_0$$

Time-averaged quantities & fluctuations deeply linked for topological qubit!

Peculiar noise sensitivity

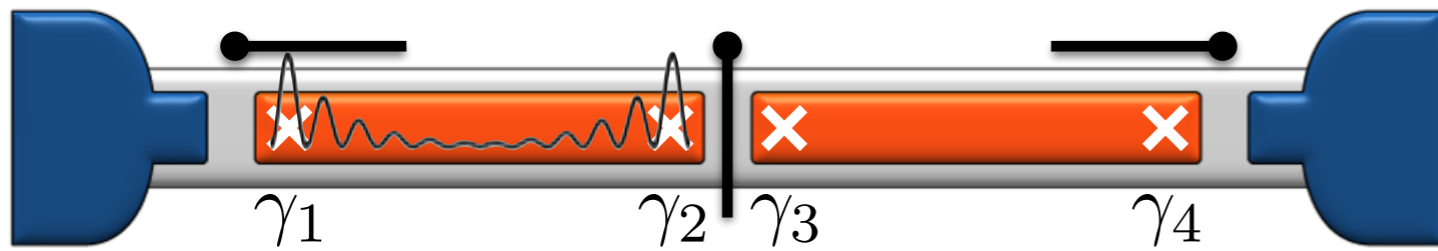

$$\omega_0 \propto \cos(\kappa L) e^{-L/\xi}$$

$$|1\rangle \begin{array}{c} \downarrow \\ \hline \end{array}$$

$$|0\rangle \begin{array}{c} \hline \uparrow \end{array}$$

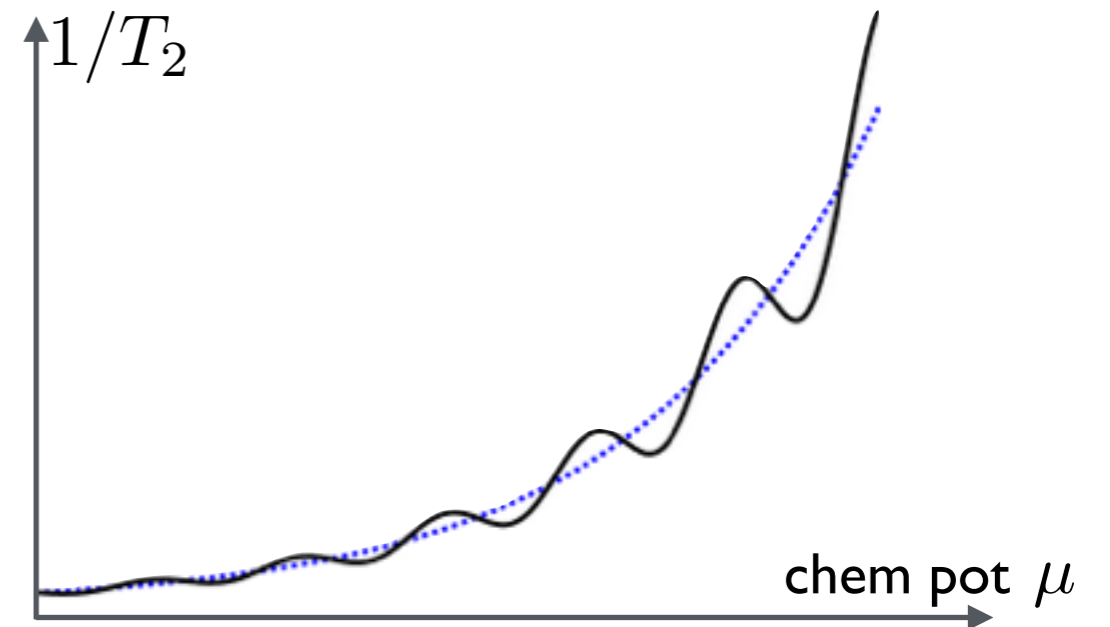
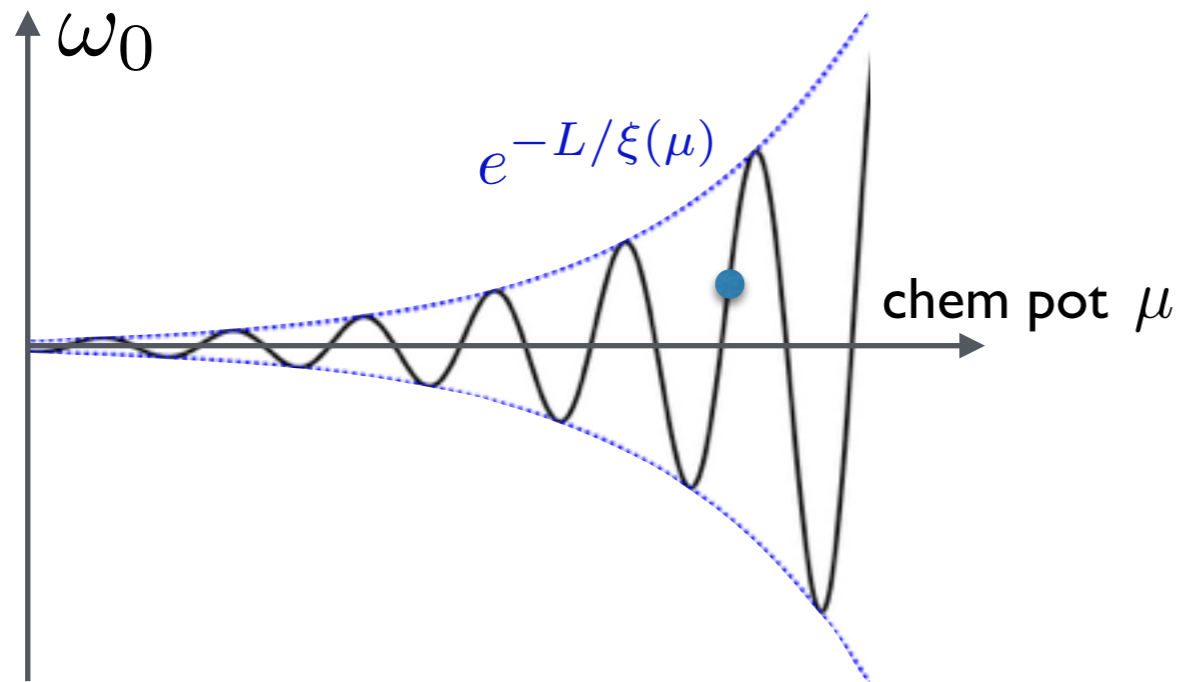

$$\omega_0 \sim \Delta E_{\text{typical}}$$

$$T_2 \sim \hbar / \Delta E_{\text{typical}}$$



$$1/T_2 \sim \omega_0$$

Time-averaged quantities & fluctuations deeply linked for topological qubit!

Measuring oscillation frequency & T_2

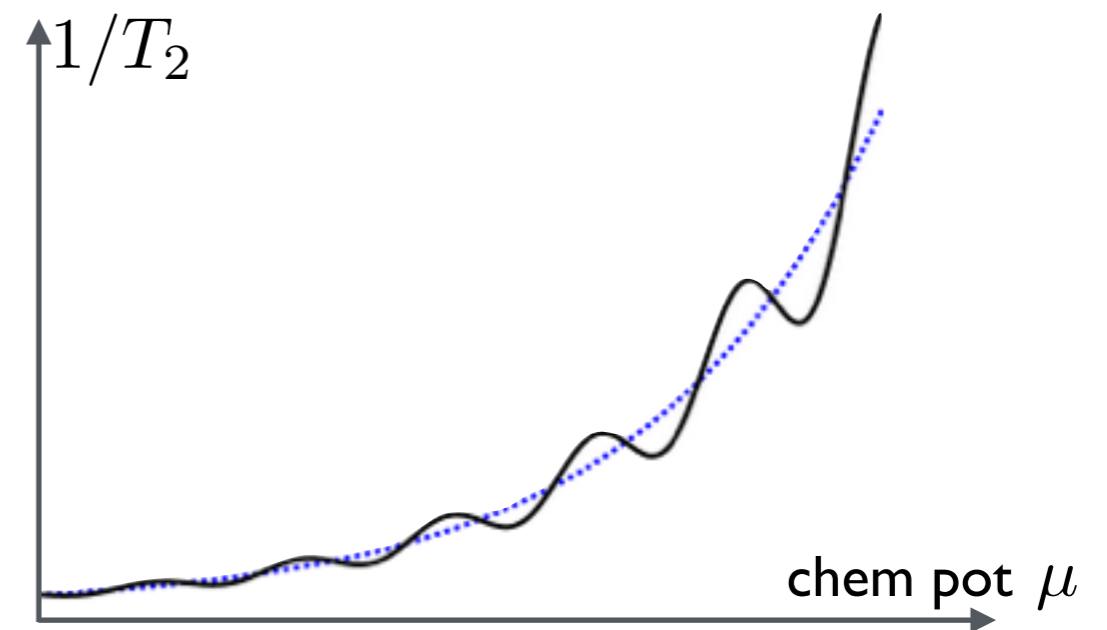
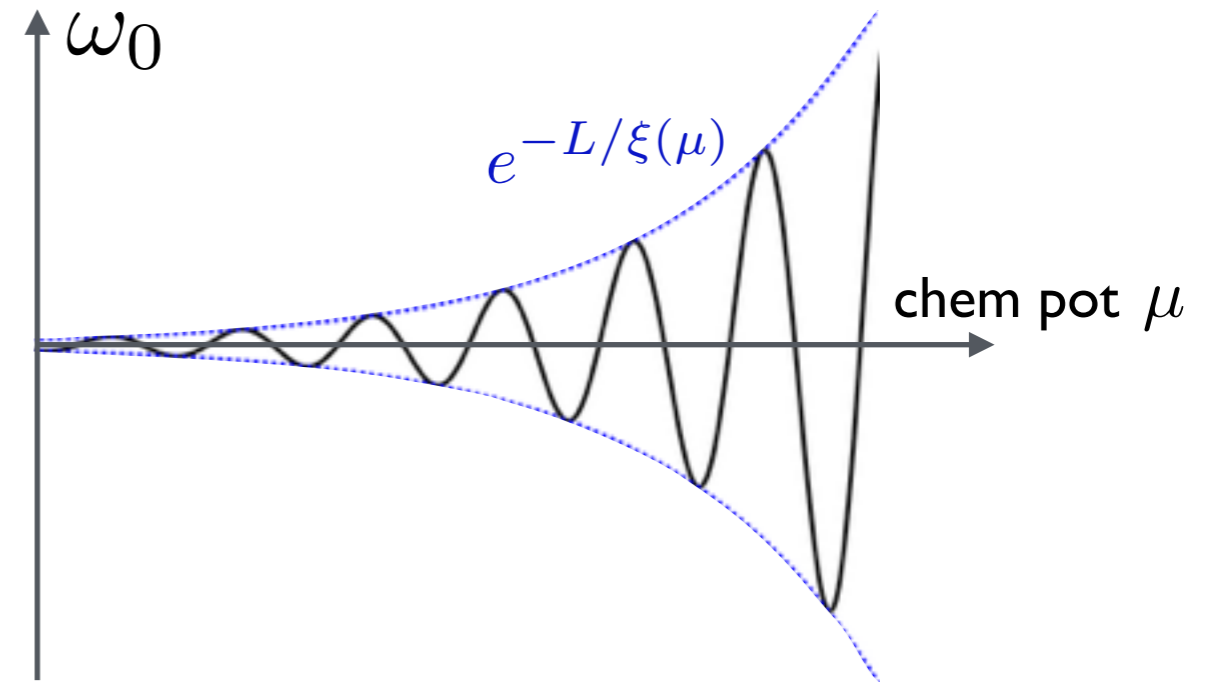
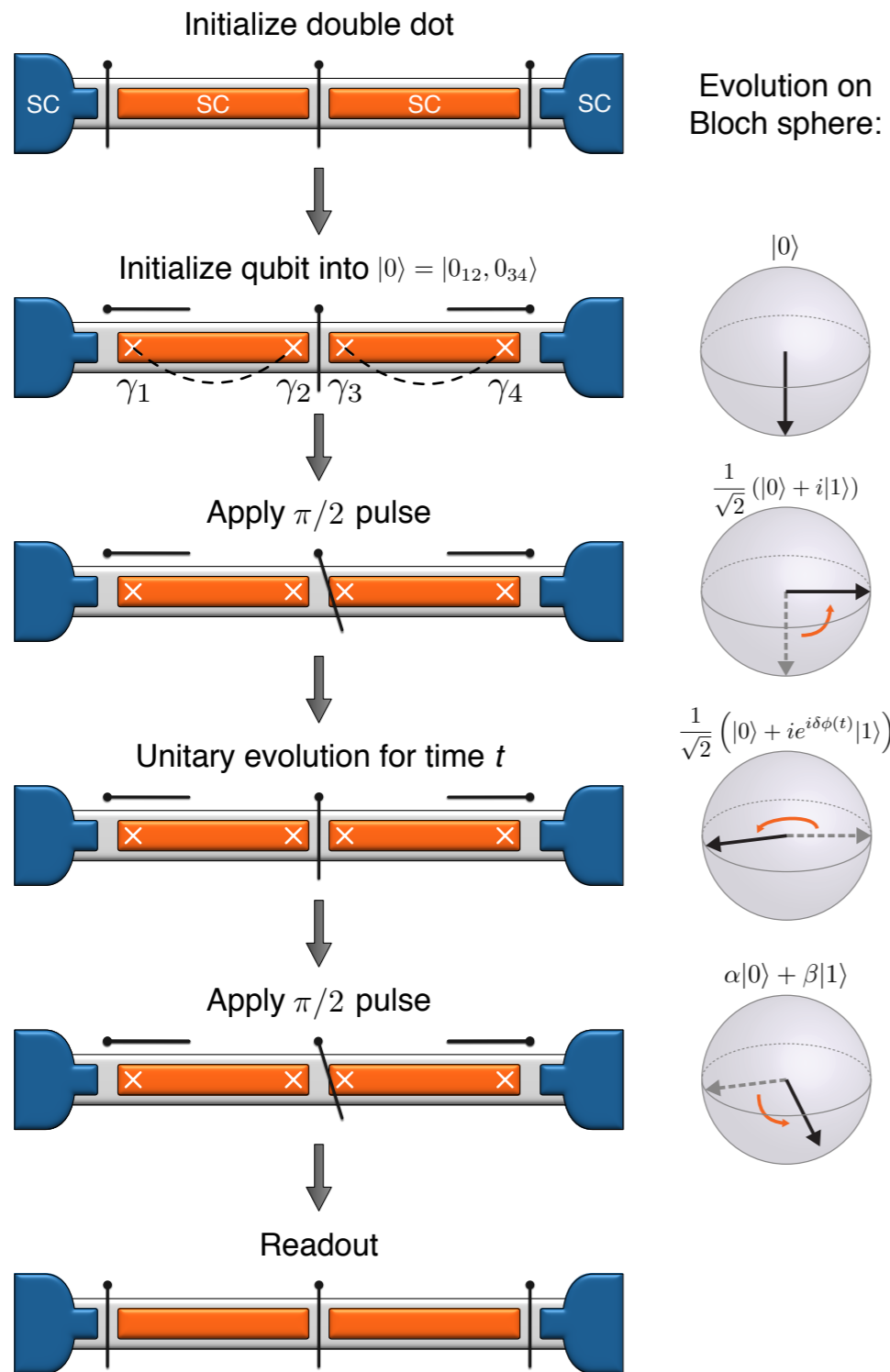

Time-averaged quantities & fluctuations deeply linked for topological qubit!

I. New all-electrical Majorana control scheme

II. Majorana-control milestones



Braiding protocol

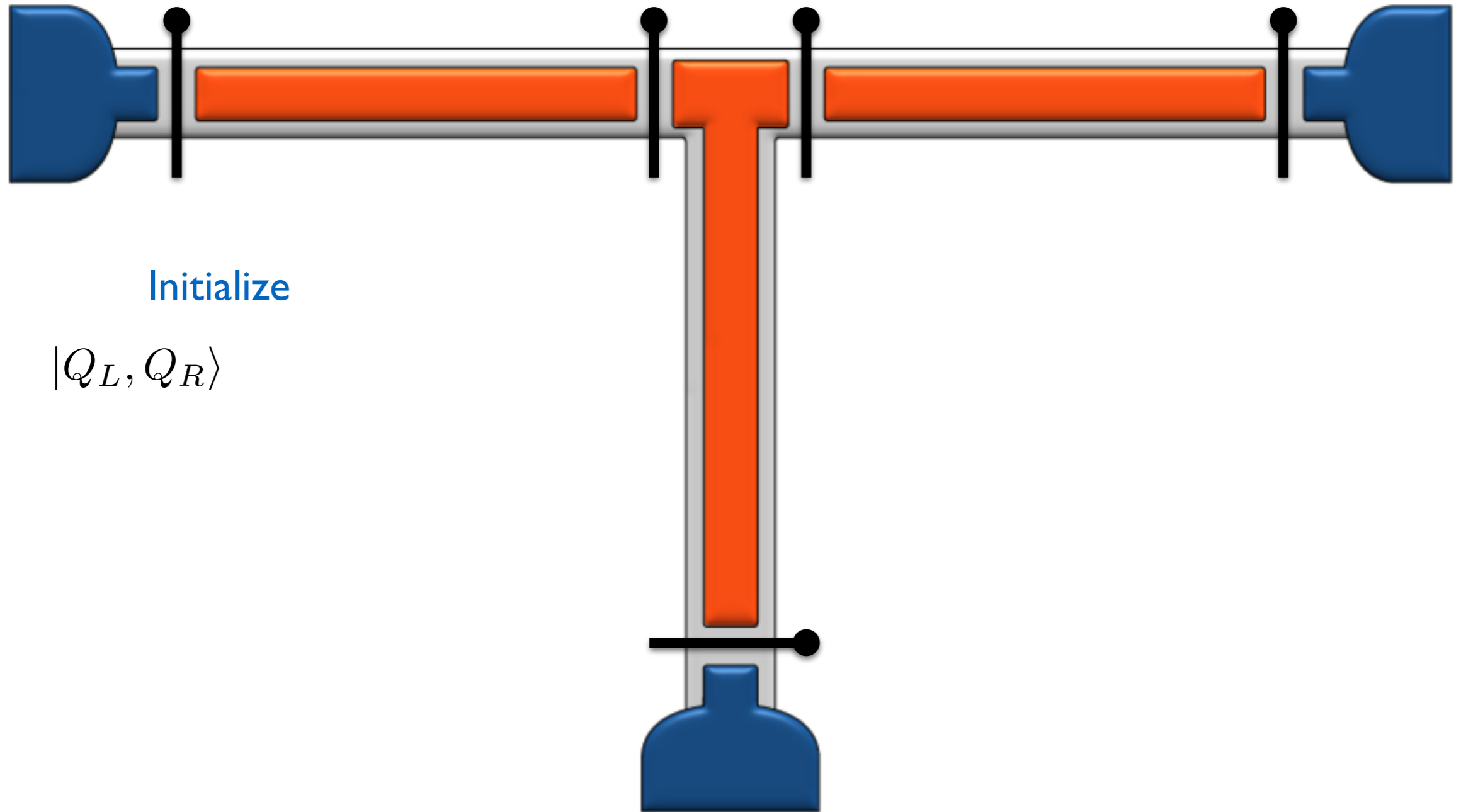

Initialize

$$|Q_L, Q_R\rangle$$

Braiding protocol

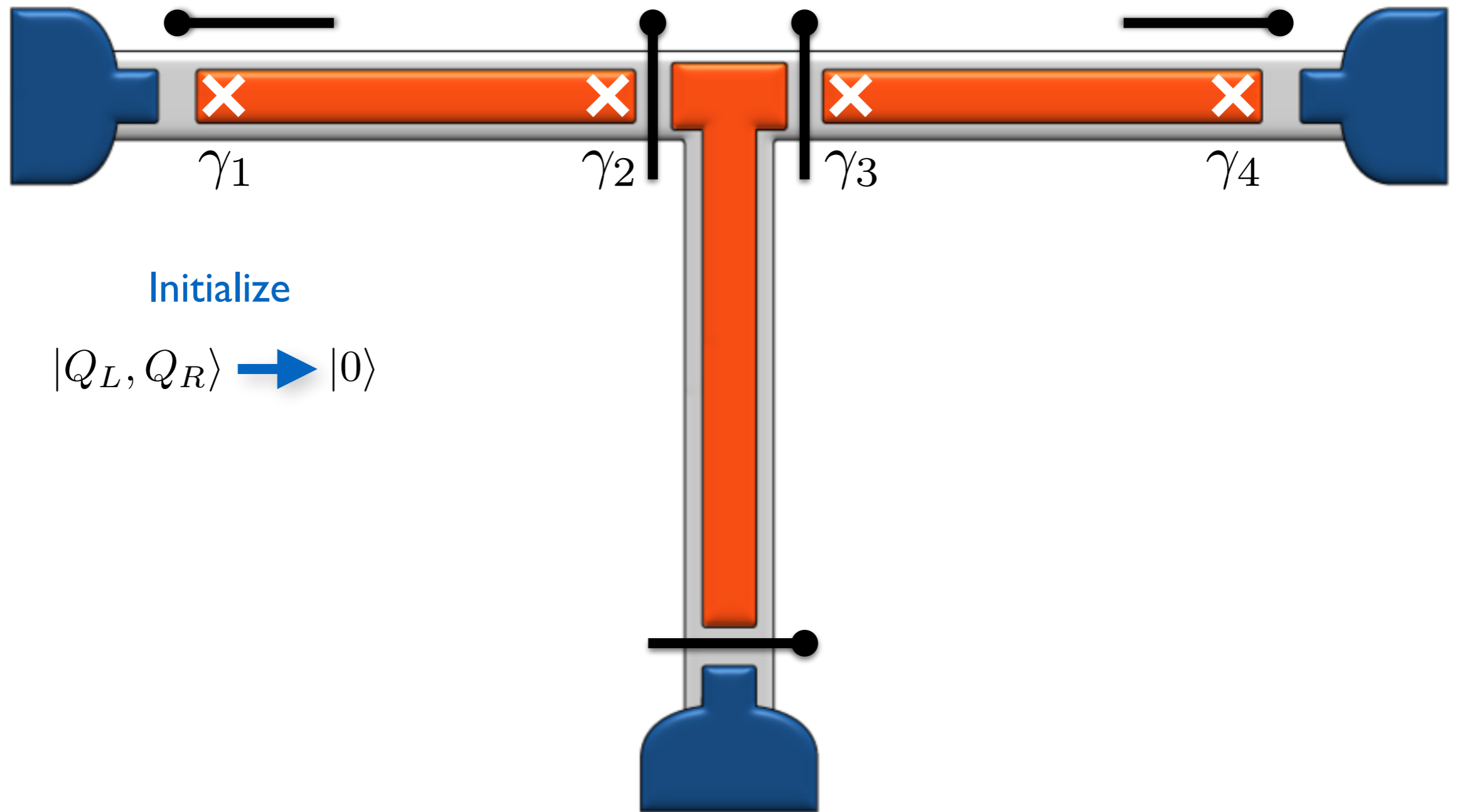

Braiding protocol

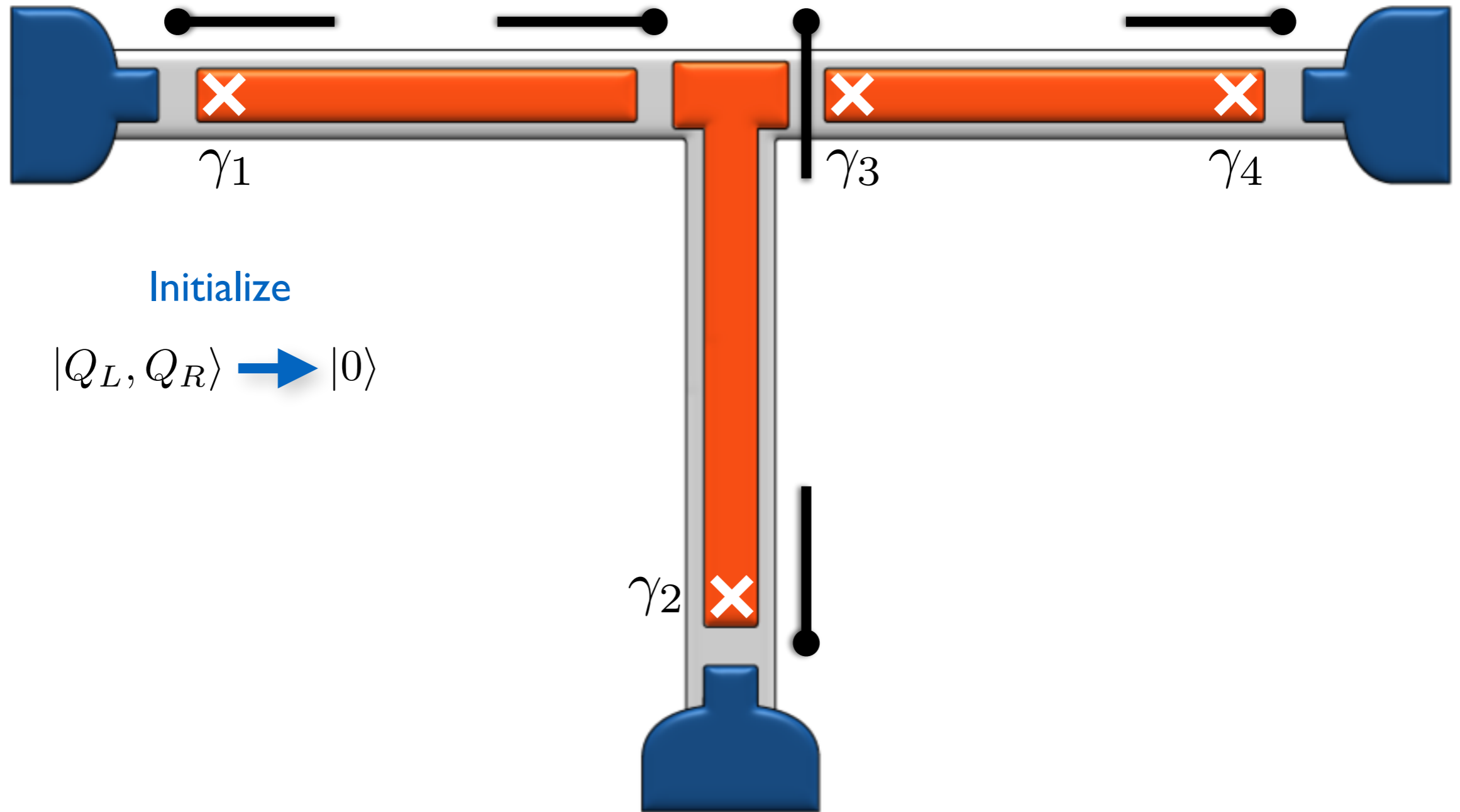

Braiding protocol

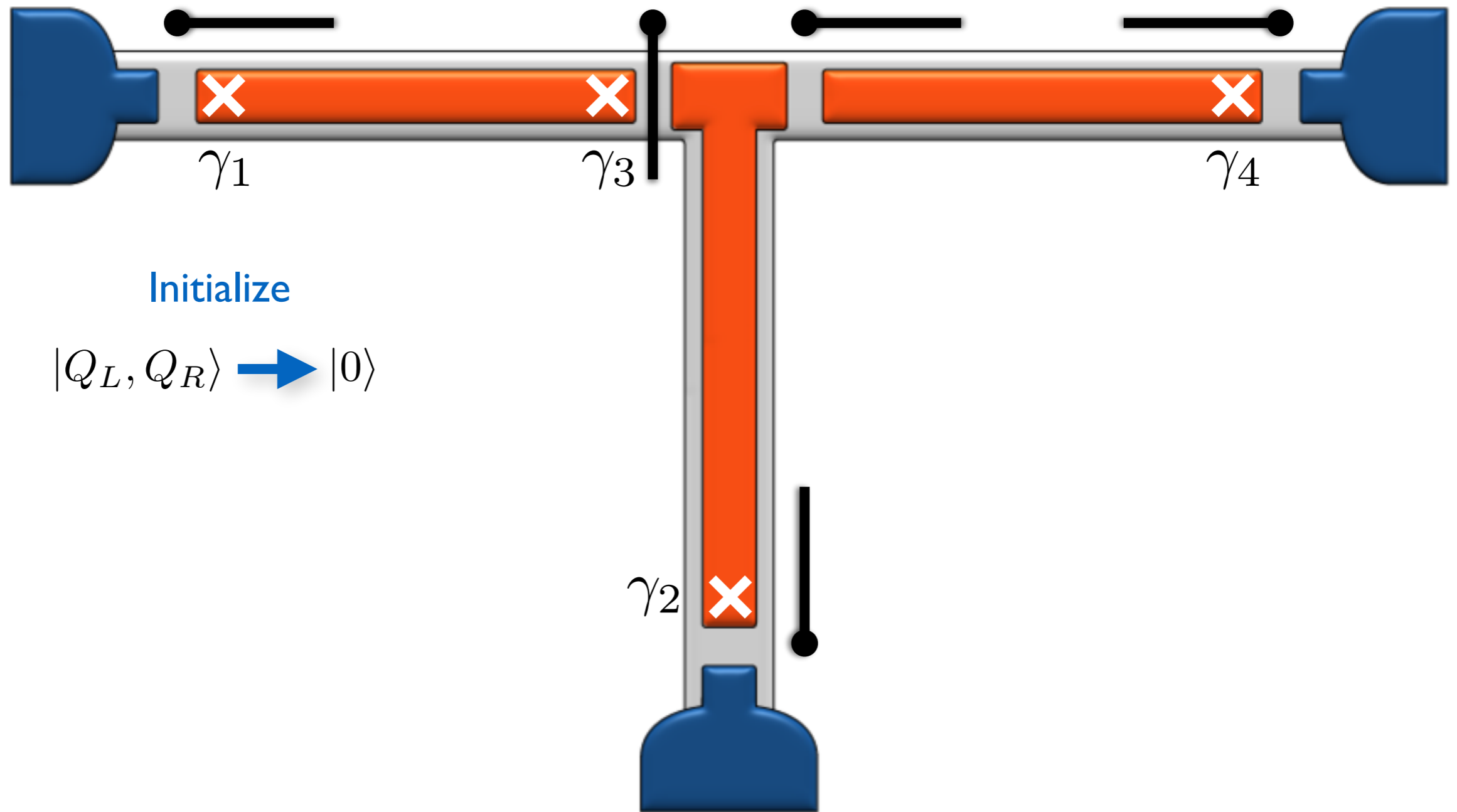

Braiding protocol

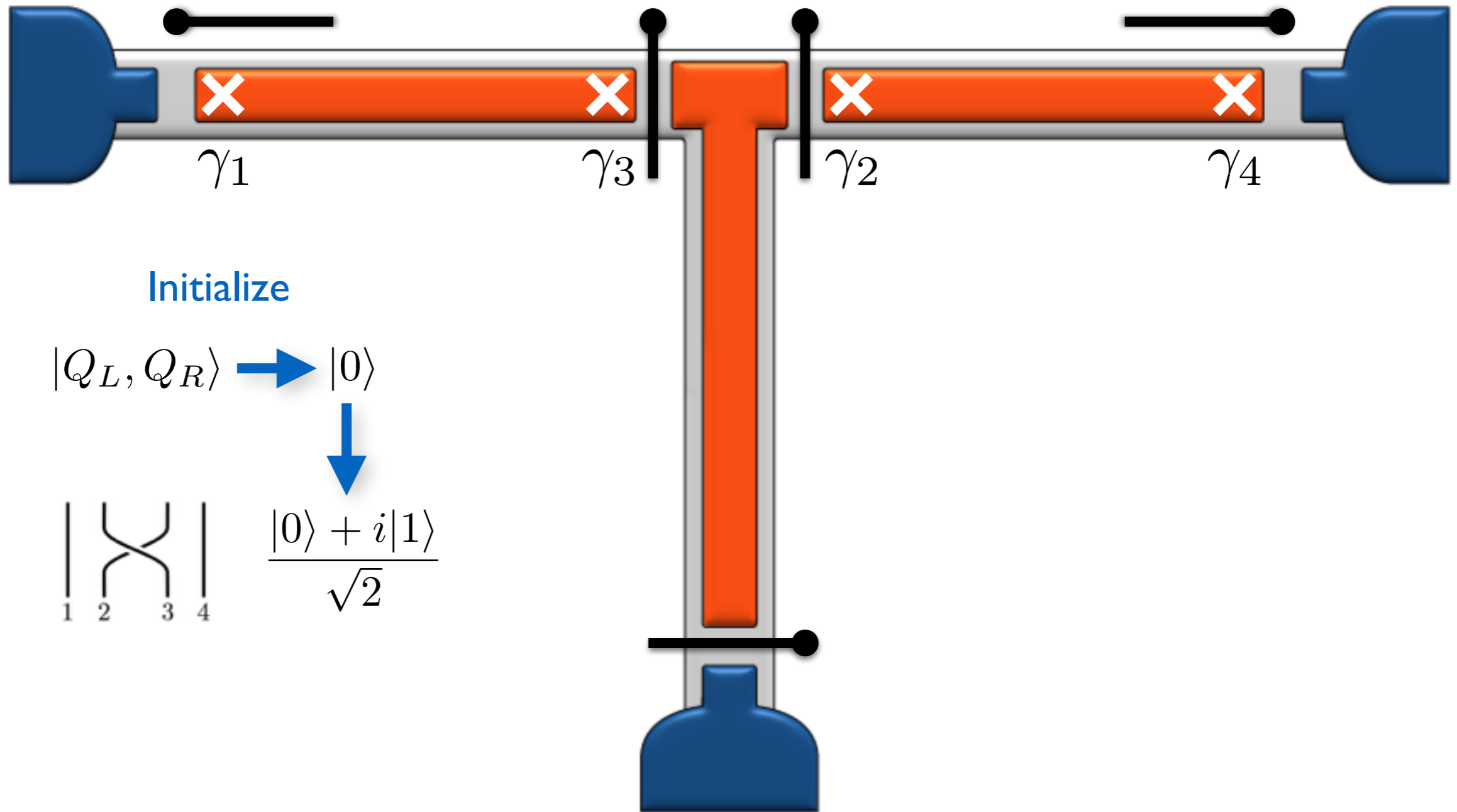

Braiding protocol

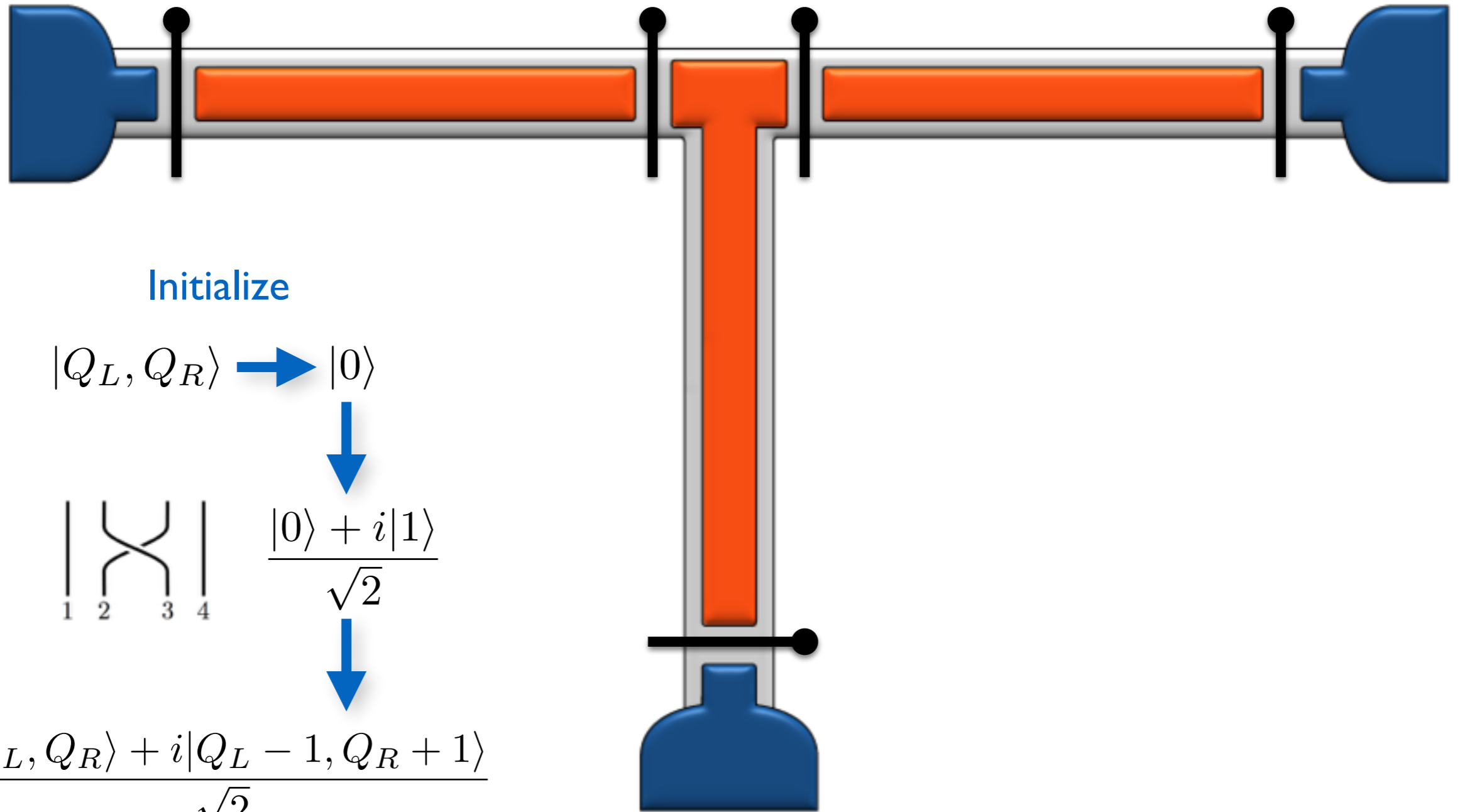

Initialize

$$|Q_L, Q_R\rangle \rightarrow |0\rangle$$

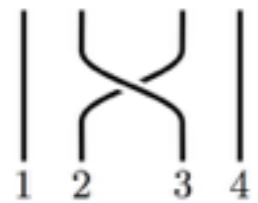

$$\frac{|0\rangle + i|1\rangle}{\sqrt{2}}$$

$$\frac{|Q_L, Q_R\rangle + i|Q_L - 1, Q_R + 1\rangle}{\sqrt{2}}$$

Readout (Probabilistic)

Braiding protocol

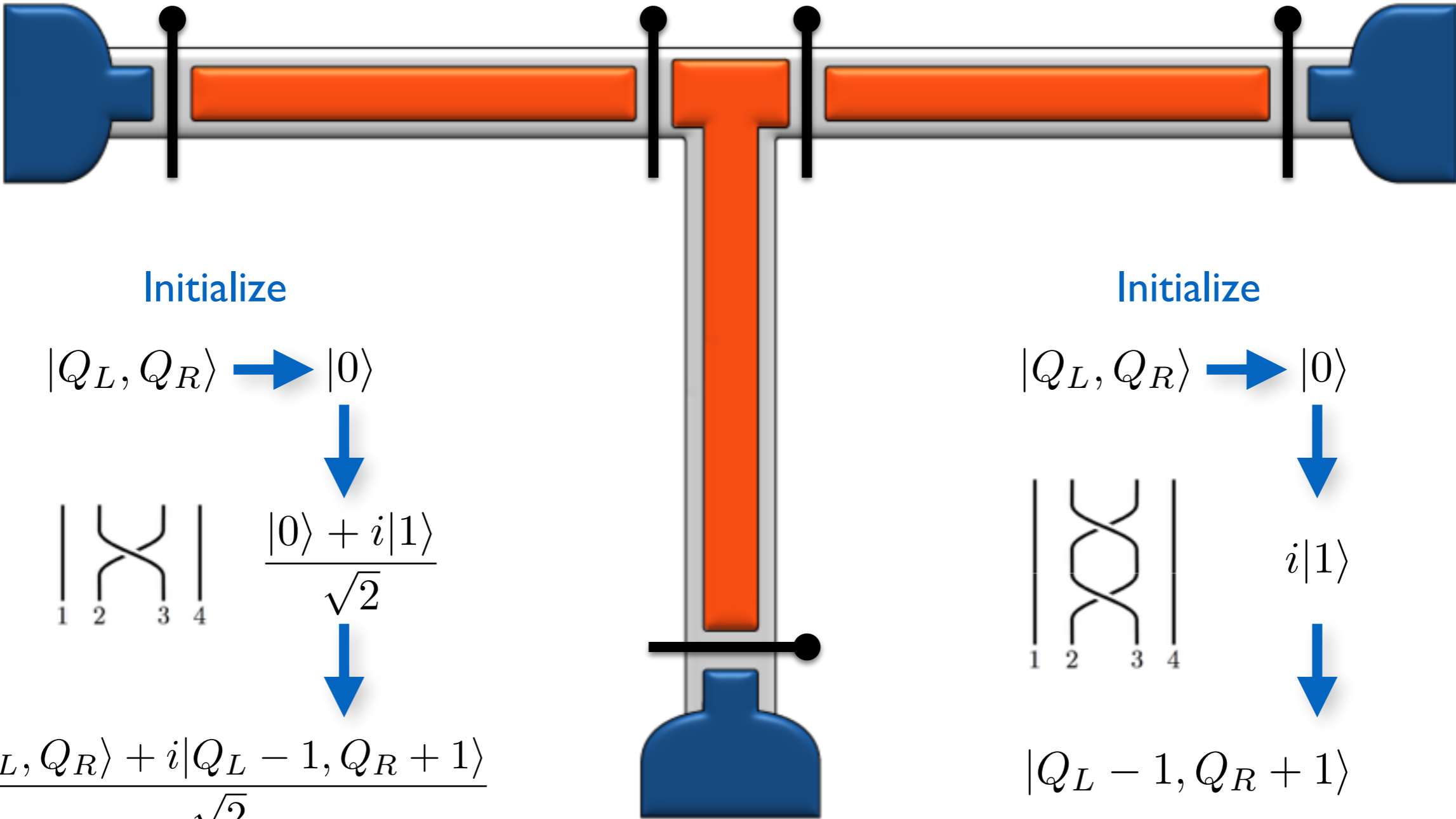

Initialize

$$|Q_L, Q_R\rangle \rightarrow |0\rangle$$

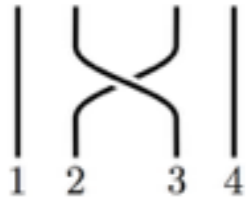

$$\frac{|0\rangle + i|1\rangle}{\sqrt{2}}$$



$$\frac{|Q_L, Q_R\rangle + i|Q_L - 1, Q_R + 1\rangle}{\sqrt{2}}$$

Readout (Probabilistic)

Initialize

$$|Q_L, Q_R\rangle \rightarrow |0\rangle$$

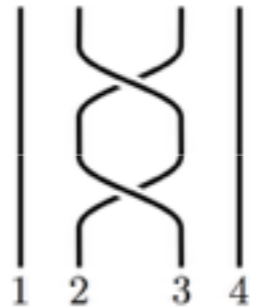

$$i|1\rangle$$



$$|Q_L - 1, Q_R + 1\rangle$$

Readout (Deterministic!)

Milestones for the Majorana control era

Fusion-rule
detection

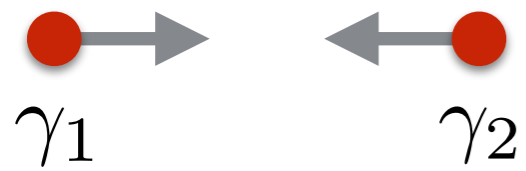

$$\sigma \times \sigma = I + \psi$$

Topological qubit
validation

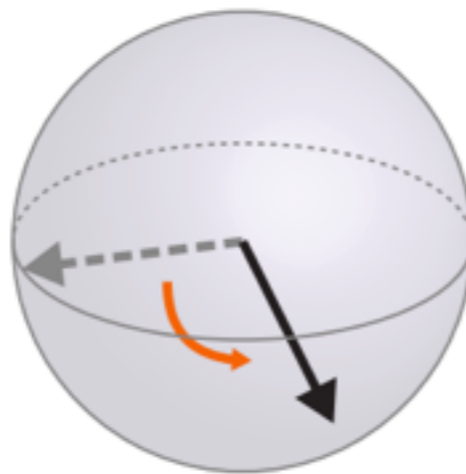

Braiding

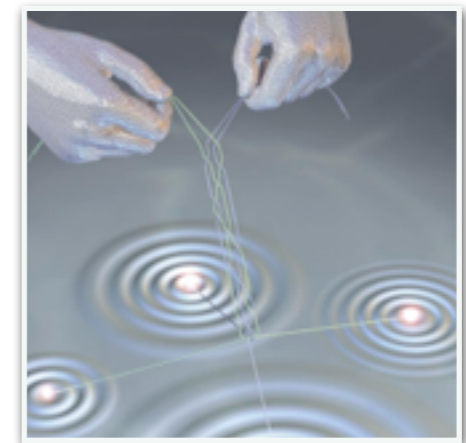

Milestones for the Majorana control era

Realizable with single-wire devices!
(May generalize to other platforms/schemes)

Fusion-rule
detection



$$\sigma \times \sigma = I + \psi$$

Topological qubit
validation

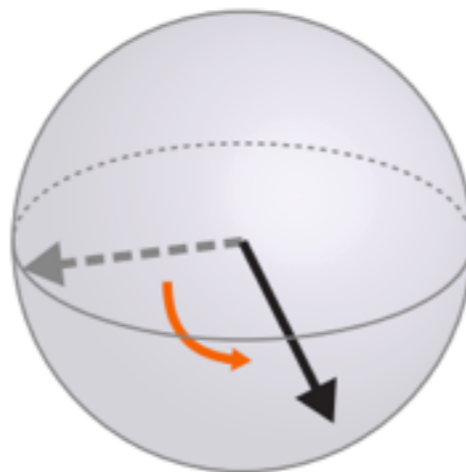

Braiding

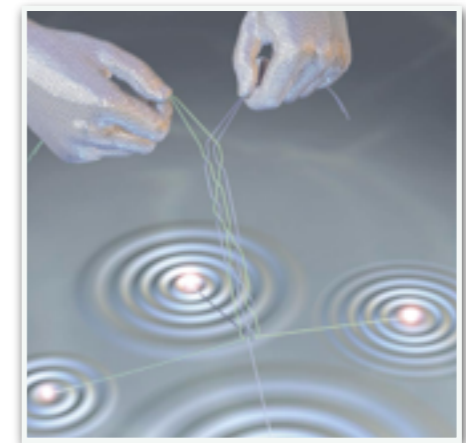

Milestones for the Majorana control era

Realizable with single-wire devices!
(May generalize to other platforms/schemes)

Fusion-rule
detection

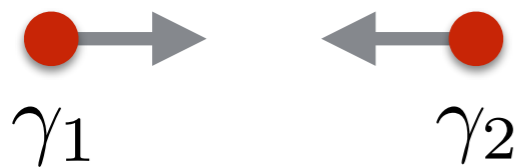

$$\sigma \times \sigma = I + \psi$$

Topological qubit
validation

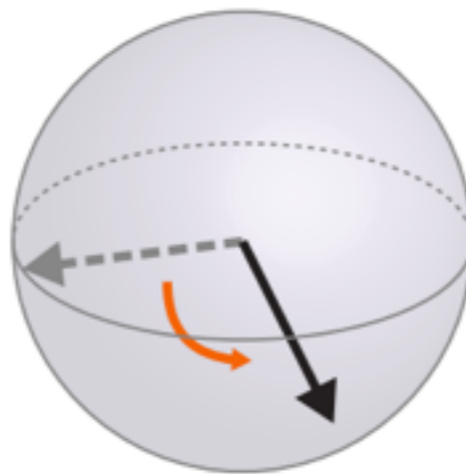

Braiding

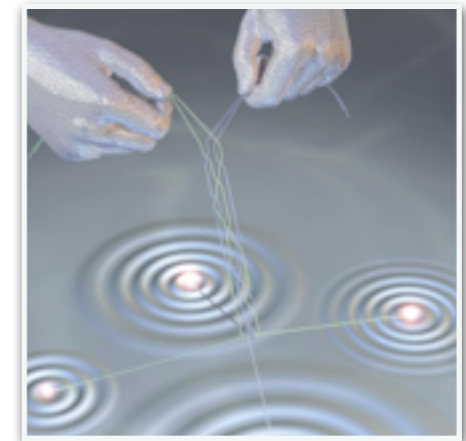

Reveals **defining** property
of non-Abelian anyons;
natural braiding precursor

Milestones for the Majorana control era

Realizable with **single-wire devices!**
(May generalize to other platforms/schemes)

Fusion-rule
detection



$$\sigma \times \sigma = I + \psi$$

Topological qubit
validation

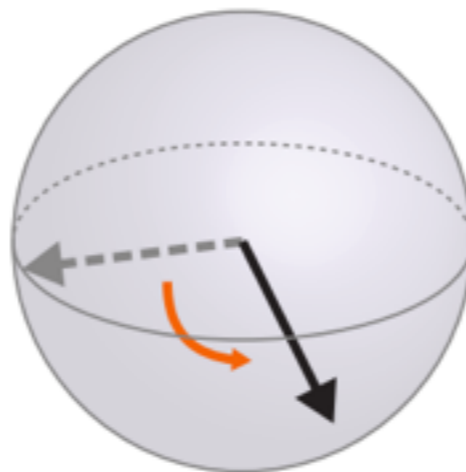

Braiding

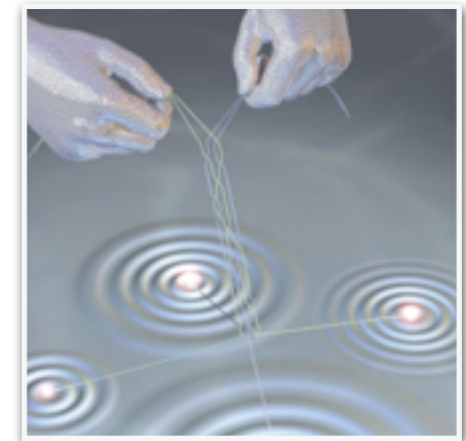

Reveals **defining** property
of non-Abelian anyons;
natural braiding precursor

Verify basic tenets of topological
quantum computing

All protocols very difficult to mimic in non-topological setups.